



বাংলাদেশ

গেজেট

অতিরিক্ত সংখ্যা

কর্তৃপক্ষ কর্তৃক প্রকাশিত

বৃহস্পতিবার, আগস্ট ১৭, ২০০৬

গণপ্রজাতন্ত্রী বাংলাদেশ সরকার

শিল্প মন্ত্রণালয়

প্রজ্ঞাপন

তারিখ, ১৮ই শ্রাবণ, ১৪১৩বাং/২রা আগস্ট, ২০০৬ইং

এস, আর, ও নং ১৯৪-আইন/২০০৬।—Standards of Weights and Measures Ordinance, 1982 (Ord. No. XII of 1982) এর section 64 এ প্রদত্ত ক্ষমতাবলে সরকার, Bangladesh Standards of Weights and Measures Rules, 1982 এর নিম্নরূপ সংশোধন করিল, যথা :-

উপরি-উক্ত Rules-এর—

(১) সর্বত্র উল্লিখিত “Director” শব্দের পরিবর্তে “Director General” শব্দগুলি প্রতিস্থাপিত হইবে ;

(২) rule 12 এর sub-rule (2) এর পর নিম্নরূপ নতুন sub-rule (৪) সংযোজিত হইবে, যথা :-

“(3) Storage tank for petroleum and petroleum products, oil tankers for edible oil, crude oil or refined oil, lighter age, barge, etc. used or intended to be used in transaction of trade and commerce, shall be calibrated, verified and certified at least once in every five years and for tank lorry at least once in a year in accordance with the provisions of the ordinance and these rules.”;

(৩) rule 18 এর sub-rule (4) এর পর নিম্নরূপ নতুন sub-rule (5) এবং sub-rule (6) সংযোজিত হইবে, যথা :-

“(5) For testing models of any weights or measures for approval, the fee shall be charged as specified in schedule XXIV.

( ৭৪৬১ )

মূল্য টাকা : ৬৪.০০

(৬) For calibration or verification and stamping of the weights, measures, weighing instruments or measuring instruments or the test weights which are used or intended to be used in industries or at the purpose of industrial metrology at the premises of any person, manufacturer, owner or user the fee shall be charged at the rate as specified in schedule XXIV.”;

(৪) rule 25 (1), 25 (3), 25 (6), এবং 27 এর “manufacture or repair” শব্দগুলির পরে “Calibrator” শব্দটি সংযোজিত হইবে ;

(৫) rule 25 এর sub-rule (4) এ উল্লিখিত “Taka twenty five” শব্দগুলির পরিবর্তে “Taka five hundred” শব্দগুলি প্রতিস্থাপিত হইবে ;

(৬) rule 26 এ উল্লিখিত “Dacca” এবং “Four” শব্দগুলির পরিবর্তে “Dhaka” এবং “six” শব্দগুলি প্রতিস্থাপিত হইবে ;

(৭) rule 30 এর sub-rule (3) এ উল্লিখিত “twenty five Taka” শব্দগুলির পরিবর্তে “Two hundred and fifty taka” শব্দগুলি প্রতিস্থাপিত হইবে ;

(৮) rule 31 এর sub-rule (3) এ উল্লিখিত “Taka 25 (twenty five)” শব্দগুলির পরিবর্তে “Two hundred and fifty taka” শব্দগুলি প্রতিস্থাপিত হইবে ;

(৯) List of Schedules এর Schedule XVIII এর পর নিম্নরূপ নতুন Schedules XIX, XX, XXI, XXII, XXIII এবং XXIV সংযোজিত হইবে, যথা :-

Schedule XIX	Base, Supplementary and Derived Units.
Schedule XX	Specification, Denomination Materials & Design of Commercial Weights & Measures.
Schedule XXI	Specification of Weighing & Measuring Instruments.
Schedule XXII	Procedure for Carrying out Calibration of Vehicle Tanks (Tank Lorry), Oil Storage Tanks, Barge etc.
Schedule XXIII	Specification for Measuring Instruments.
Schedule XXIV	Fees for Verification, Calibrations of Tank Lorry, Storage Tank, Barge etc. Fees for Weights, Measures, Weighing Instrument & Measuring Instruments which is used for Industrial Scientific Metrology.

(১০) Schedule 1 এর clause 1.4 এর table এর কলাম ২ এর প্রথম লাইনে উল্লিখিত “ $\neq$ mg” অভিব্যক্তি এর পরিবর্তে “ $\pm$  mg” অভিব্যক্তি প্রতিস্থাপিত হইবে ;



(১১) Schedule V এর Table 1 এর “r” এবং “o” এর বিদ্যমান dimension সমূহের পরিবর্তে নিম্নরূপ Dimension সমূহ প্রতিস্থাপিত হইবে, যথাঃ—

**“Limits of error to be tolerated.**

±mg

Normal Value	r	o
5 kg	18	22
10 kg	20	24
20 kg	20	24
50 kg	20	24”

(১২) Schedule V এর Table 1 এর পর নিম্নরূপ নতুন Table 1A সংযোজিত হইবে, যথাঃ—

**“Table-1A. Dimensions of Rectangular Bar Weight (In mm)**

**TYPE-2**

Denomination	A	A <sub>1</sub>	B	B <sub>1</sub>	H	a	b	c	d	d/d	r	o	m	n	p
5kg	150	152	75	77	84	36	30	6	66	19	5	12	16	13	55
10kg	190	193	95	97	109	46	38	8	84	21	6	16	35	25	70
20kg	230	234	115	117	139	61	52	12	109	29	8	20	50	30	95
50kg	310	314	155	157	192	83	74	16	152	40	10	25	70	40	148”

(১৩) Schedule V এর Part 1 এর clause 2 এর শিরোনামাধীন “Flat Cylindrical Weights” শব্দগুলির পরিবর্তে “Flat Rectangular Weights” শব্দগুলি প্রতিস্থাপিত হইবে ;

(১৪) Schedule V এর Part 1 এর Table II এর কলাম D (dia) তে উল্লিখিত এন্ট্রিসমূহ যথাক্রমে 30, 16, 16, 13, 14, 10, এবং ৮ এর পরিবর্তে এন্ট্রি যথাক্রমে 24, 12, 12, 10, 10, 10, এবং ১০ এন্ট্রিসমূহ প্রতিস্থাপিত হইবে ;

(১৫) Schedule V এর Part 1 এর clause 4 এর sub-clause 4.1 এর চিত্রের প্রথম কলামের শিরোনাম “Kilogram Series” এর পরে সংখ্যা “২০” সংযোজিত হইবে ;

(১৬) Schedule V এর Part 1 এর Table III এর কলাম ১ এর ৩নং ক্রমিকে উল্লিখিত এন্ট্রি “10 kg” এর বিপরীতে ১৩নং সারিতে উল্লিখিত এন্ট্রি “2” এর পরিবর্তে এন্ট্রি “২২” প্রতিস্থাপিত হইবে ;

(১৭) Schedule V এর Part 1II এর clause 2.2.1 এর শেষে “The measures may also be made of steel or brass pipes. The brass pipe may preferably conform to the description given in Annexure V.” বাক্যগুলি ও ফুটনটপগুলি সন্নিবেশিত হইবে ;

(১৮) Schedule V এর Part IV এর Table I এর শিরোনামে উল্লিখিত এন্ট্রিসমূহ “O O” এর স্থলে এন্ট্রি “O এ” সমূহ প্রতিস্থাপিত হইবে ;

(১৯) Schedule V এর Part IV এর Table II এর Note-2 এর প্রথমাংশে উল্লিখিত “Tolerance on dimensions + percent” এর স্থলে “Tolerance on dimensions ± percent” শব্দ ও চিহ্নসমূহ প্রতিস্থাপিত হইবে ;

(২০) Schedule V এ উল্লিখিত “Dispensing Measures” শিরোনামাধীন “Part IV” এর পরিবর্তে “Part ৪” শব্দ ও সংখ্যা প্রতিস্থাপিত হইবে ;

(২১) Schedule VI এর Part IX এ উল্লিখিত “Limits of Errors for Automatic machines to be tolerated” শিরোনামাধীন “TABLE XIX” এর পরিবর্তে “TABLE XIV” শব্দ ও সংখ্যা প্রতিস্থাপিত হইবে ;

(২২) Schedule VII এর clause 1 এর এন্ট্রিসমূহ যথাক্রমে “0.01 (10)<sup>2</sup>, 0.001 (10)<sup>-3</sup>, এবং 0.000001 (10)<sup>-6</sup>” এর পরিবর্তে যথাক্রমে, “0.01 or 10<sup>-2</sup>, 0.001 or 10<sup>-3</sup>, এবং 0.000001 or 10<sup>-6</sup>” এন্ট্রিসমূহ প্রতিস্থাপিত হইবে ;

(২৩) Schedule VIII এর শেষে নিম্নরূপ নতুন একসেট সীল সংযোজিত হইবে, যথা ঃ—

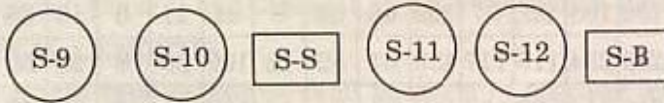

(২৪) Schedule X এর Part 1 এর clause 3.17 এর শর্তাংশের দ্বিতীয় লাইনের প্রথমাংশে উল্লিখিত “Lubricant oil” শব্দগুলির পরিবর্তে “Lubricating oil” শব্দগুলি প্রতিস্থাপিত হইবে ;

(২৫) Schedule XI এর Fees for verification শিরোনামাধীন—

(ক) clause 1 এর Weights শিরোনামাধীন—(a) Bullion Weights, (b) Brass Weights (other than bullion), (c) Sheet Metal Weights (other than bullion), (d) Iron and Steel Weights, (e) Carat Weights এর প্রতিটি ডিনোমিনেশনের ভেরিফিকেশন ফিস যথাক্রমে, “৩.০০” টাকার স্থলে “৯.০০” টাকা, “১.৫০” টাকার স্থলে “৪.৫০” টাকা, “১.০০” টাকার স্থলে “৩.০০” টাকা, এবং “০.৫০” টাকার স্থলে “১.৫০” টাকা প্রতিস্থাপিত হইবে ;

(খ) clause 2 এর Weights শিরোনামাধীন—Liquid Capacity Measures (Including Dispensing Measure) এর প্রতিটি ডিনোমিনেশনের ভেরিফিকেশন ফিস যথাক্রমে, “৩.০০” টাকার স্থলে “৯.০০” টাকা, “১.৫০” টাকার স্থলে “৪.৫০” টাকা এবং “১.০০” টাকার স্থলে “৩.০০” টাকা প্রতিস্থাপিত হইবে ;



- (গ) clause 3 এর Length Measure শিরোনামাধীন—প্রতিটি ডিনোমিনেশনের ভেরিফিকেশন ফিস যথাক্রমে, “৩.০০” টাকার হলে “৯.০০” টাকা, “১.৫০” টাকার হলে “৪.৫০” টাকা এবং “১.০০” টাকার হলে “৩.০০” টাকা প্রতিস্থাপিত হইবে ;
- (ঘ) clause 4 এর Weighing Instruments other than Beam Scale of class “C” and “D” Capacity শিরোনামাধীন—প্রতিটি ওজন যন্ত্রের ক্ষেত্রে স্ট্যাম্পিং ফিস তিনগুণ বৃদ্ধি হইয়া প্রতিস্থাপিত হইবে ;
- (ঙ) clause 5 এর Beam Scale of class “C” and “D” শিরোনামাধীন—প্রতিটি ওজন যন্ত্রের ক্ষেত্রে স্ট্যাম্পিং ফিস তিনগুণ বৃদ্ধি হইয়া প্রতিস্থাপিত হইবে ;
- (চ) clause 6 এর Measuring Instruments (Petrol pumps) শিরোনামাধীন—প্রতিটি Dispensing Unit এর ক্ষেত্রে স্ট্যাম্পিং ফিস দুইগুণ বৃদ্ধি হইয়া প্রতিস্থাপিত হইবে ;

(২৬) Schedule XIII এর Fees for granting certificates of approval in respect of a model relating to any weight and measure শিরোনামাধীন—Manufacturer, Repairer শব্দগুলির পর Calibrator শব্দটি সংযোজিত হইবে এবং সকল প্রকার সনদ (Dealer ব্যতীত) ইস্যু ও নবায়ন এর ফিস যথাক্রমে, “500.00 per year” সংখ্যাগুলি ও শব্দগুলির পরিবর্তে “1000.00 per year” সংখ্যাগুলি ও শব্দগুলি প্রতিস্থাপিত হইবে ;

(২৭) Schedule XIV এর দ্বিতীয় লাইনে উল্লিখিত শিরোনাম “Register of licensed/certified manufacturers, repairers and dealers” এর পরিবর্তে “Register of licensed/certified manufacturers, repairers, dealers and calibrator” শিরোনাম প্রতিস্থাপিত হইবে ;

(২৮) Schedule XV এর দ্বিতীয় ও তৃতীয় লাইনে “Director” শব্দের পরে দুইবার উল্লিখিত “BDSI” শব্দের পরিবর্তে “BSTI” শব্দ প্রতিস্থাপিত হইবে ;

(২৯) Schedule XVI এর শিরোনাম “Form to be maintained by the manufacturer/repairer/dealer” এর পরিবর্তে শিরোনাম “Form to be maintained by the manufacturer/repairer/dealer/calibrator” প্রতিস্থাপিত হইবে ;

(৩০) Schedule XVIII এর Application form এর মধ্যমাংশে উল্লিখিত “Tk. 25” শব্দ ও সংখ্যার পরিবর্তে “Two hundred and fifty taka” শব্দগুলি প্রতিস্থাপিত হইবে ;

(৩১) Schedule XIX এর শিরোনাম “Certain units of weights and measures” এর পরিবর্তে শিরোনাম “Base, Supplementary and Derived Units” প্রতিস্থাপিত হইবে ;



(৩২) Schedule XIX এর পর নিম্নরূপ নতুন Schedule XX, XXI, XXII, XXIII এবং XXIV সংযোজিত হইবে, যথা :—

**“Schedule XX**

**(See Rule 10)**

**Specifications, denominations, Materials and design of Commercial Length measures.**

**PART-1**

**FABRIC OR PLASTIC TAPE MEASURE**

**1. GENERAL**

(a) This part deals with fabric or plastic tape measures which are used for measurements where the use of rigid length measures is not convenient or practicable.

(b) Tape measures of 0.5 m to 5 m, made of materials specified in clause 4(b), are intended to be used for, measurements required in the tailoring trade, anatomical measurements or household measurements. Tape measures of 5 m and above made of materials specified in clause 4(c) are intended to be used for measurements of buildings, roads, timber and timber products and for other similar measurements but not for measurements of land, storage tanks, fermentation vats and other similar measurements.

**2. CLASSES OF ACCURACY**

Fabric or plastic tape measure shall be divided into three classes of accuracy namely, Class I, Class II and Class III, in accordance with their accuracy.

**3. NOMINAL LENGTHS**

Fabric or plastic tape measures shall be made in nominal lengths of 0.5 m, 1 m, 1.5 m, 2 m, 3 m, 4 m, 5 m or multiples of 5 metres, provided that the maximum nominal length shall not exceed 100 metres.

**NOTE :** The nominal length of a fabric or plastic tape measure is the distance at the reference temperature of 20°C between the initial and terminal graduation lines, when the tape measure is stretched, in the wet or dry condition, and without friction, on a horizontal plane surface, under a extension of 20 newtons. The length so measured shall be equal, within the limits of maximum permissible errors, to the nominal length of the tape measure.

**4. MATERIAL**

(a) The materials used shall be adequately strong, stable and resistant to atmospheric conditions under the normal conditions of use and shall comply with the following requirements :

- (i) When ordinarily used at temperatures between  $\pm 8^{\circ}\text{C}$  of the reference temperature, the variation in length of the tape measure shall not exceed the maximum permissible error.
- (ii) When used with a change of  $\pm 10$  per cent in the tension, the variation in length of the tape measure shall not exceed the maximum permissible error.



- (b) Tape measures of nominal length 0.5m to 5m.
- (i) The tape measure may be made from a suitable fabric or plastic material.
  - (ii) The fabric shall be coated with suitable paints, enamels or other suitable coating so as to give the tape measure a good finish. All coatings shall be non-cracking and water resistant.
- (c) Tape measure of nominal length above 5 m.
- (i) If made from fabrics, the fabric may be reinforced length-wise with rust-proof and rigid wires of metal or other equivalent material.
  - (ii) If made from plastic materials, the tape measure shall be reinforced length-wise by means of rust-proof and rigid wires of metal or glass fibers.
  - (iii) If made from any other material, the tape measure shall satisfy the conditions specified in clause 4(a).

## 5. MANUFACTURE

- (a) General :
- (i) Tape measures shall be well-made, robust and carefully finished.
  - (ii) The cross section of the tape measures shall have such dimension and shape that, under normal conditions of use it allows the tape measure to have the accuracy specified for its class.
  - (iii) Tape measures shall be so made that when they are stretched over a plane surface their edges are practically straight and parallel.
  - (iv) The rings, winding, devices or other devices shall be attached to the tape in such a manner that they do not cause any inaccuracy or permanent deformation in the tape.
- (b) Tape measures of nominal length 0.5m to 5m.
- (i) Tape measures of nominal length 0.5m to 5m shall have a width of not less than 5mm and not more than 25mm.
  - (ii) If not wound on a spool or in a case, both the ends of the tape measure shall be reinforced with plastic or metal strips, of the same width as the.
  - (iii) Tape measure, over a length of not less than 10mm or more than 10mm.
  - (iv) If wound on a spool or in a case, the tape measure shall have a metal ring or other device securely attached to the outer end of the tape measure. A device for retraction or winding of the tape shall be provided.
- (c) Tape measure of nominal length above 5 m.
- The tape measures shall a width of not less than 10 mm and a thickness between 0.3 and 0.6 mm.
- A metal ring shall be securely attached to the outer end of each tape measure. The ring shall be securely fastened to the tape measure by a metal strip of the same width as the tape.



The outer end of the tape measure shall be reinforced over a length of not less than 100 mm by a strip of leather or other suitable material of the same width as the tape measure. The strip shall pass round the inner end of the ring and under the metal strip.

**NOTE :** This strip, besides serving as a protective device shall also be utilised for affixing the stamp of verification.

The tape measure shall be rolled into a suitable container or wound on a winding device, made of metal plastic, leather or other suitable material.

## 6. GRADUATIONS

### (a) General requirements :

- (i) Graduation lines shall be clear, uniform, indelible and so made as to ensure easy and unambiguous reading.
- (ii) The value of the graduation shall be of the form  $1 \times 10n$ ,  $2 \times 10n$ , or  $5 \times 10n$ , the exponent "n" being positive or negative whole number of zero.

The value of the graduation, however, shall not exceed :

- 1 cm, on measure of nominal length less than or equal to 2 m.
  - 10 cm, on measures of nominal length more than 2 m, but less than 10 m.
  - 20 cm, on measures of nominal length more than 10 m, but less than 50 m.
  - 50 cm, on measures of nominal length equal to or more than 50 m.
- (iii) Graduation lines shall be reasonably straight, perpendicular to the axis of the tape measures and of uniform thickness throughout their length.
  - (iv) Graduation lines shall be so made that they form a clear and distinct scale and their thickness does not cause any inaccuracy of reading.
  - (v) The tape measure shall be graduated only in metric units and graduations or other indications showing or relating to units other than metric units shall not be made on any surface of the tape measure.

### (b) Tape measures of nominal length 0.5m to 5m.

- (i) The zero graduation line may be located at the outer end of the ring or other device or may commence on the tape itself at a length equal to or greater than 50mm from the outer end of the ring or other device.
- (ii) The tape measures may be graduated throughout at every millimetre or every 5 mm.
- (iii) The graduation lines at every 10mm shall be marked in such a manner that there is no confusion between the 10mm lines and the millimetre or 5 mm lines.
- (iv) The tape measures may be graduated on one side or both the sides. If the tape is graduated on one side, the manufacturer's name, trade mark, advertisement or other similar matter may be printed on the ungraduated side of the tape measure.



- (c) Tape measures of nominal length above 5 m.
- (i) The zero graduation line may be located at the outer end of the metal ring or on the tape itself, at a length equal to or greater than 100 mm from the outer end of the ring.
  - (ii) The tape measures may be graduated through out at every millimetre, every 5 millimetres or every 10 millimetres.
  - (iii) The graduation lines at every 10 mm shall be marked in such a manner that there is no confusion between the 10 mm graduation lines and the millimetre or 5mm graduation line.
  - (iv) The graduation lines at every 10 mm shall have a length approximately half the width of the tape.
  - (v) Every graduation line at 50 mm shall have the same length as the graduation line at 10 mm but may have an arrow at its end. This requirement shall not apply to tape measures graduated at every millimetre.
  - (vi) The zero graduation line, the graduation lines at every 100 millimetres and at every metre shall have a length equal to the width of the tape.

## 7. NUMBERING

- (a) General requirements :
- (i) The numerals shall be indicated clearly, uniformly and indelibly and shall be easily and unambiguously legible.
  - (ii) The places, dimensions, shape, colour and contrast of the numerals shall be suitable for the scale and graduation lines to which they relate.
  - (iii) The numerals shall be marked parallel to or perpendicular to the axis of the tape measure depending upon the intended manner of use of the measure.
- (b) On tape measures of nominal length 0.5m to 5m.
- (i) every graduation line at 10 mm shall be marked with the complete number of centimetres and
- Explanation**—The graduation number marked may be, for example 122 and not 22 after completion of one metre.
- (ii) the height of the numerals shall not exceed two-thirds of the width of the tape measures.
- (c) On tape measures of nominal length above 5m
- (i) The graduation lines at every 100 mm and at every metre shall be numbered. The numerals shall have a height of not more than two-thirds of the width of the tape.
  - (ii) The metre graduations shall be accompanied by the symbol 'm' and, if required, 'মি'.
  - (iii) After the graduation line at one metre, every graduation line at 100 mm may be marked with an additional numeral indicating the completed number of metres. This numeral, if provided, may be located just above, below or in line with the numeral of the 100mm graduation line. The height of the numeral may be approximately half the height of the numerals indicating 100mm.



## 8. MAXIMUM PERMISSIBLE ERROR

- (i) On verification, under the conditions specified in clause 2, the error on the length between the axis of any two graduation lines shall not exceed :

for Class I  $\pm (0.1 + 0.1)$  mm  
 for Class II  $\pm (0.3 + 0.2L)$  mm, and  
 for Class III  $\pm (0.6 + 0.4L)$  mm ;

where L is the length between the two graduation lines concerned, expressed in metres, rounded off to the next higher whole number of metres.

- (ii) The maximum permissible error on tape measures on inspection shall be twice that specified for verification, the methods of verification remaining unchanged.
- (iii) Tape measures of nominal length 0.5m to 5m shall belong to accuracy Class II or Class III.
- (iv) Tape measures of nominal length above 5m shall belong to accuracy Class I, Class II or Class III.

## 9. MARKINGS

- (a) Tape measures of nominal length 0.5m to 5m.

The tape measures and the case or container, if provided shall be marked at a suitable place with the following markings :

- (i) nominal length in metres ;  
 (ii) manufacturer's name or trade mark or both ;  
 (iii) class of accuracy II or III in an oval.

- (b) Tape measures of nominal length above 5m.

The tape measure and the case or container or other device, where provided shall be marked near the zero graduation line and on the container, case or other device with the following markings :

- (i) nominal length in metres ;  
 (ii) manufacturer's name or trade mark or both ;  
 (iii) class of accuracy : I, II or III in an oval.

- (c) The inscriptions shall be clearly visible and legible.

- (d) Advertising inscriptions, if made, shall be carried out of such a manner that they do not intrude in any way with the use of the tape measure.

## 10. SEALING

The stamp of verification shall be affixed on the metal, plastic, leather or other strip provided at the beginning of the tape measures.



**PART-2****STEEL TAPE MEASURES****1. GENERAL**

This part deals with steel tape measures which are used for measurements where the use of rigid length measures is not convenient or practicable.

**2. CLASSES OF ACCURACY**

Steel tape measures shall be divided into three classes, namely, Class I, Class II and Class III, in accordance with their accuracy.

**3. NOMINAL LENGTHS**

The tape measures shall be made in nominal lengths of 0.5m, 1m, 1.5m, 2m, 3m, 4m, 5m or multiples of 5m, provided that the maximum nominal length not exceed 200m.

**NOTE :** The nominal length of a steel tape measure is the distance at the reference temperature of  $\pm 0^{\circ}\text{C}$ , between the initial and terminal graduation lines, when the tape measure is stretched, without friction, on a horizontal plane surface, under a tension of 50 newtons. The length so measured shall be equal, within the limits of maximum permissible errors, to the nominal length of the tape measure.

**4. MATERIALS**

(a) The materials used shall be adequately strong, stable and resistant to environmental influences under normal conditions of use and shall comply with the following requirements :

- (i) When ordinarily used at temperatures between  $\pm 0^{\circ}\text{C}$  of the reference temperature, variation in length of the temperatures shall not exceed the maximum permissible error.
- (ii) When used with a change to  $\pm$  per cent in the tension, the variation in length of the tape measure shall not exceed the maximum permissible error.

(b) The tape measure shall be made from steel or stainless steel.

**5. MANUFACTURE**

(a) Tape measures shall be well made robust and carefully finished. (see Fig. 3 to 7)

(b) The cross section of the tape measure shall have such dimension and shape that, under normal conditions of use, it allows the tape measure to have the accuracy specified for its class.

**NOTE :** It is recommended for guidance of manufactures and users that tape measures may have a width of not less than 5mm and a maximum thickness of 0.4 mm.



- (c) The steel tape measure shall be so made that when it is stretched on a plane surface, the edges are practically straight and parallel.
- (d) At the zero end, tape measures shall be provided, with a ring or other device for facilitating withdrawal. The ring or other device, when provided, shall be fastened to the tape measure by a metal strip of the same width as the tape.
- (e) The tape measures shall be capable of being wound into suitable container or other winding device of robust construction and made of metal, plastic, leather or other suitable material.
- (f) The winding devices shall be so designed that they do not cause any inaccuracy or permanent deformation in the tape.
- (g) The edges of tape measures shall be slightly rounded.
- (h) The tape measure shall be provided with a rust proof coating and shall be free from burrs.

## 6. GRADUATIONS

### (a) General requirements :

- (i) Graduation lines shall be clear, uniform, indelible and so made as to ensure easy and unambiguous reading.
- (ii) The value of the graduations shall be of the form  $1 \times 10^n$ ,  $2 \times 10^n$  or  $5 \times 10^n$  metres, the exponent 'n' being a positive or negative whole number or zero.

The value of graduation, however, shall not exceed :

1 cm, on measures of nominal length less than or equal to 2m,

10 cm, on measures of nominal length more than 2m but less than 10m.

20 cm, on measures of nominal length more than 10m, but less than 50 m.

50 cm, on measures of nominal length equal to or more than 50 m.

- (iii) Graduation lines shall be reasonably straight perpendicular to the axis of the tape measure, and of uniform thickness throughout their length.
- (iv) Graduation lines shall be so made that they form a clear and distinct scale and that their thickness does not cause any inaccuracy of reading.
- (v) The tape measure shall be graduated only in metric units and graduation or other indications showing or relating to units other than metric units shall not be made on only surface of the tape measure.
- (b) Tape measures above 5m to 200m shall be graduated only on one side. Tape measures of 0.5m to 5m may be graduated on both sides. (only metric scale)



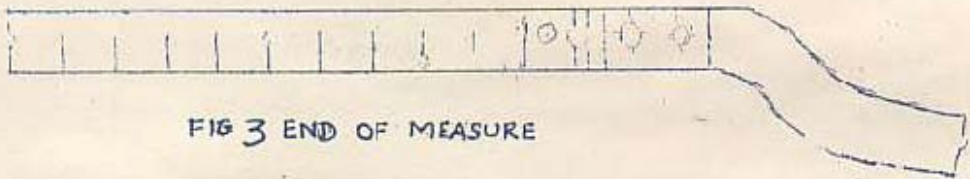

FIG 3 END OF MEASURE

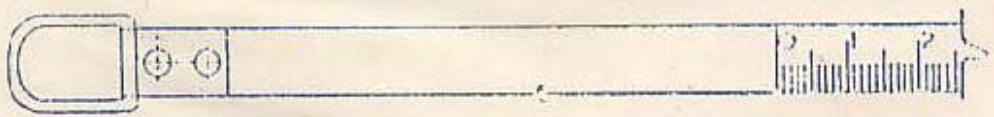

FIG 4 MEASURE WITH ZERO AWAY FROM RING

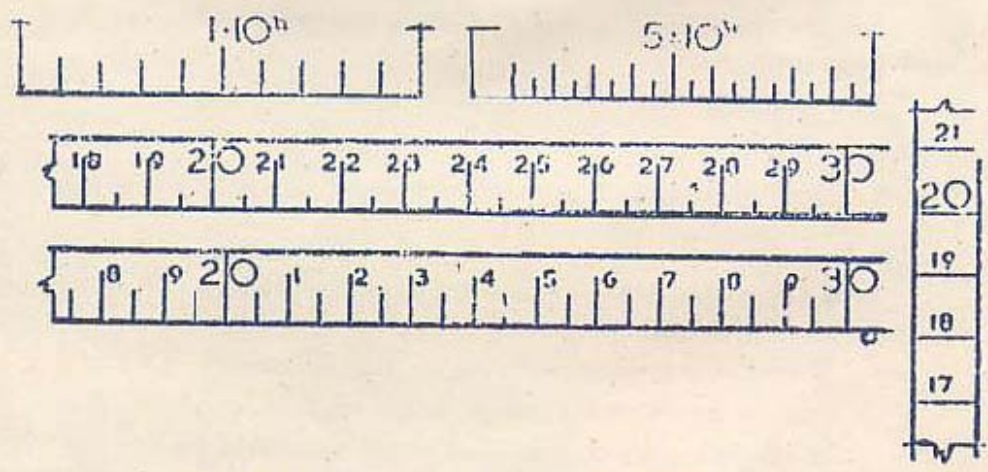

Fig-5. The Example of Graduation Lines and Numbering.



FIG 5 ILLUSTRATION OF MEASURE COMMENCING WITH ZERO



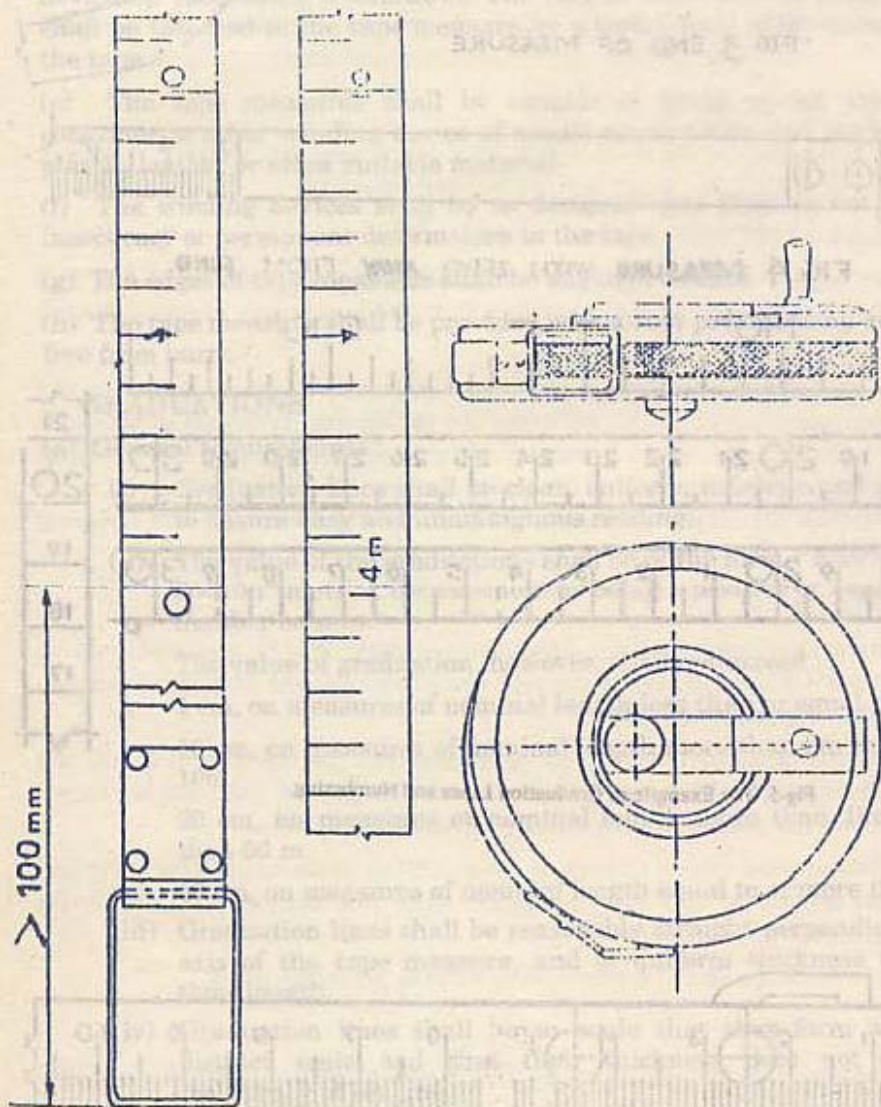

ILLUSTRATION OF LONG MEASURE OF FABRIC OR  
GLASS FIBRE AND CONTAINER  
Figure 7



- (c) The graduated lines, numbers and other markings shall be either in relief, engraved, typo-graphically printed or made in any other suitable manner.
- (d) The zero of the scale may be located at the outer or inner edge of the ring or other device, or may also be located on the tape measure itself, at a length equal to or greater than :
- (i) 50m from the outer end of the ring or other device, in the case of tape measures of nominal length 0.5m to 5m ; and
  - (ii) 100 mm from the outer end of the ring or other device, in the case of tape measures of nominal lengths above 5m.
- (e) Tape measures of denominations 0.5m to 5m may be graduated throughout at every millimetre, every 5 millimetres or every 10 millimetres.
- (i) The graduation lines at every 10mm shall be marked in such a manner that there is no confusion between the 100mm graduation lines and the millimetre or 5m graduation lines.
  - (ii) In the case of tape measures graduated every 5mm or 10mm, not less than the first 100mm shall be subdivided into millimetres.
- (f) In the case of tape measures of nominal length above 5m, every graduation line 50mm shall have the same length as the graduation line at 10mm but may have an arrow at its end. This requirement shall not apply to tape measures graduated at every millimetre.
- (g) The thickness of the graduation lines shall not exceed the following limits :
- 0.4mm in the case of Class I and Class II tape measures, and 0.5mm in the case of Class III tape measures.
- (h) In the case of tape measures of nominal length 0.5m to 5m, the graduation lines may have a length between one-fourth and full width of the tape, depending upon convenience. In the case of tape measures of nominal length above 5m, the length of the graduation lines may be as follows :—
- (i) for millimetre graduation lines, about one-third of the width of the tape ;
  - (ii) for 5 millimetre graduation lines, about half the width of the tape ;
  - (iii) for 10 millimetre graduation lines, about two-thirds the width of the tape; and
  - (iv) for 100 millimetre graduation lines and for metre graduation lines as well as for the zero graduation lines, equal to the width of the tape.



## 7. NUMBERING

(a) General requirements :

- (i) The numerals shall be indicated clearly, uniformly and indelibly and shall be easily and unambiguously legible.
- (ii) The place, dimension, shape, colour and contrast of the numerals shall be suitable for the scale and the graduation lines to which they relate.
- (iii) The numerals shall be marked parallel to or perpendicular to the axis of the tape measure depending upon the intended manner of use of the measure.

(b) The following graduation lines shall be numbered :

10mm, for tape measures of nominal length 0.5 to 5m. 100 mm, for tape measures of nominal length exceeding 5 m.

(c) The metre graduation lines shall be numbered and accompanied by the symbol 'm' and if required 'মি'।

(d) In the case of the tape measures of nominal length of 0.5 m to 5m, the height of the numerals shall be such as would facilitate the reading of the measurement without ambiguity.

(e) In the case of tape measures of nominal length 5m and above, after the graduation line at one metre, every graduation line at 100 mm may be marked with an additional numeral, indicating the completed number of metres. This numeral, if provided, may be located just above below or in line with the numeral of the 100 mm graduation line. The height of this numeral may be approximately half the height of the numerals indicating 100 mm.

(f) In the case of tape measures of nominal length measured above the height of the numerals, except those given in sub-clause (e) above, may be :

- (i) above  $1/3$  of the width of the tape, for 10 mm graduation lines,
- (ii) above  $1/2$  of the width of the tape, for 100 mm graduation lines, and
- (iii) above  $2/3$  of the width of the tape, for metre graduation lines.

(g) If tapes of 0.5 m to 5 m are contained in special container may be marked with its dimension, for example, 50 mm to facilitate measurement of internal dimensions.



## 8. MAXIMUM PERMISSIBLE ERROR

- (a) On verification, under the conditions specified in clause 2, the error on the length between the axis of any two graduation lines shall not exceed :
- for Class I  $\pm (0.1 \pm 0.1L)$  mm  
 for Class II  $\pm (0.3 \pm 0.2 L)$  mm, and  
 for Class III  $\pm (0.6 \pm 0.4 L)$  mm,  
 where L is length between two graduation lines concerned, expressed in metres, rounded off to the next higher whole number of metres.
- (b) The maximum permissible error on tape measures on inspection shall be twice that specified for verification, the method of verification remaining unchanged.
- (c) Steel tape measures of nominal length 0.5m to 5m shall belong to accuracy Class I or Class II.
- (d) Tape measures of nominal length above 5m to 200m shall belong to accuracy Class I, Class II or Class III.

## 9. MARKING

- (a) The steel tape measures shall be marked at a suitable place near the end and on the container, where provided with the following markings :
- (i) nominal length in metres;
  - (ii) an indication of the location of the zero of the scale,
  - (iii) the manufacturers name or trade mark or both,
  - (iv) class of accuracy : I, II or III in an oval,
- (b) The inscription shall be clearly visible and legible.
- (c) Advertising inscription, if made, shall be carried out in such a manner that they do not intrude in any way with the use of the tape measure.

## 10. SEALING

The stamp of verification shall be affixed on the metal, or other device affixed at the beginning of the tape measure.



## PART-3

## SURVEYING CHAINS

## 1. GENERAL

This part deals with link surveying chains of 20m and 30m lengths for land measurement.

## 2. DEFINITIONS

- (a) **Surveying Chain**—An instrument for measuring the surface distance between two points.
- (b) **Length of Chain**—The distance between the outside edges of the handles when fully stretched.
- (c) **Tallies**—Metallic tags or indicators of distinctive pattern fixed at (various points) of the chain, to facilitate quick reading of fractions of a chain.

## 3. MATERIAL

The different components of the chains shall be made from the materials mentioned against each.

<u>Components</u>	<u>Material</u>
Handle	Brass castings
Eye Bolt Collar	Brass suitable for free cutting and high speed machine work
Ring, Link, Small Link, Large Link, Connecting	Galvanized Mild Steel Wire 4mm
Tally	Brass Sheet or Galvanized sheet
Indicating Ring	Brass Wire

## 4. CONSTRUCTIONAL DETAILS

- (a) The nomenclature of the different parts of the chain and their dimensions shall be as indicated in Figs. 8, 9 & 10.
- (b) The Tallies shall be fixed at every fifth metre along the chain. Small rings shall be fixed at every metre, except where tallies are attached. Tallies shall have distinctive shapes depending on their position in the chain as shown in Figs. 8 and 9.
- (c) Connecting links between two large links shall be oval in shape, the central one being a circular ring.



- (d) To facilitate holding the arrows (chain pails) in position with the handle of the chain, a groove shall be cut on the outside surface of the handle as shown in Fig. 10. The radius of the groove shall correspond to the radius of the arrows.
- (e) The handle joint shall have flexibility in order that it may be possible to swivel the handle round the eye bolt. A swivel may also be provided at the middle of the chain.

### 5. PERMISSIBLE ERROR

- (a) When measured with a tension of 80 newtons every metre length shall be correct with an error not exceeding  $\pm 2\text{mm}$ .

The overall length of the chains shall be correct within the following limits of error :

20 metre chains  $\pm 5\text{mm}$

30 metre chains  $\pm 8\text{mm}$

- (b) The permissible errors shall be the same for verification and inspection'.

**Explanation :** Nominal distance between the centers of the circular links containing the small rings or tallies shall define the distance.

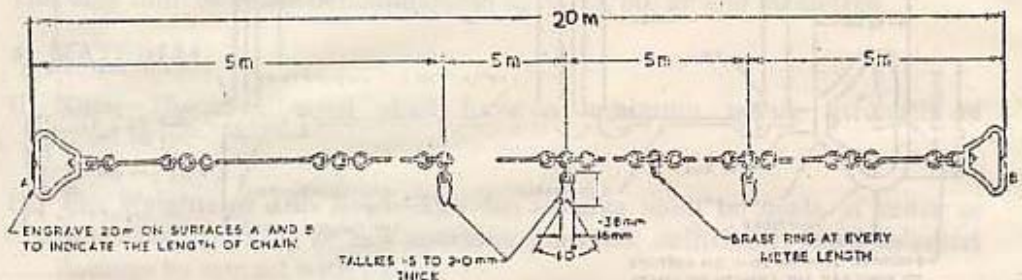

Fig. 8, 20 meter chain







**6. MARKING**

- (a) The tallies used for marking the distance in chain shall be marked with letter 'm' and 'মি' (see Fig. 10).
- (b) The length of the chain, 20m or 30m, as the case may be, shall be indelibly marked over the handle (See Fig. 10).
- (c) The chains shall be indelibly marked, on the reverse side of the surface of the handle having the denominations with the manufacturer's name or trade mark.

**7. PROVISION FOR STAMPING**

A metal label or disc shall be permanently attached to the handle at the beginning of each chain for the verification of stamp.

**PART-4****TAPES FOR USE IN MEASUREMENTS OF OIL QUANTITIES****1. GENERAL**

This part covers the requirements of tape with the dip weight attached to its end to be used in gauging petroleum, petroleum products and other oils.

**2. DEFINITIONS**

A dip tape shall mean essentially a graduated steel tape in one continuous length used in conjunction with a dip weight.

**3. DENOMINATIONS**

The tape shall be of the denominations 5, 10, 15, 20, 25 and 50 metres.

**4. MATERIAL**

- (i) Tape—The steel used shall have a minimum tensile strength of 1500 M pa.
- (ii) Dip Weights or Dip Bobs—The dip weights shall be made of brass or other non-sparking or low sparking material, sufficiently hard to resist damage by contact with steel.

**5. DIP TAPE**

- (a) The dip tape shall be of the following dimensions :

Width : 13mm or 16mm

Thickness : Between 0.20 and 0.30 mm



**Length** : One continuous piece of sufficient length for the purpose required. The tape shall be longer than the distance between the dip reference point and the bottom of the container.

**(b) Graduations**

The dip tape shall be marked legibly and indelibly on one side only with a line at every millimetre or five millimetres, centimetre, decimetre and metre. The height of marking lines shall be as follows :

Unit of graduations	Approximate height of graduation mm
Millimetre	4
Five Millimetres	6
Centimetre	3
Decimetre	Full width of the tape
Metre	Full width of the tape

- (c) The tape shall be so made that it is capable of being wound on a drum and held in a winding frame or case.
- (d) The free end of the tape shall be fitted with the dip weight or arrangements provided for attaching the dip weight.

**6. DIP WEIGHTS**

(a) Dip weights shall be of two types, light and heavy, and shall be of cylindrical torpedo shape. The dimensions for light and heavy dip weights shall be as shown in Fig. 11.

(b) The light type may either be fixed permanently to the tape or attached separately to it by any suitable device.

(c) The heavy type shall be attached to the tape by a swivel hook (See Fig. 12).



(d) The dip weight shall have the lengths of graduation and weights given below :

	Light	Heavy
Length of graduations from Bottom	150mm	150mm
Weight	700 ± 50g	1500 ± 50g

(e) The dip weight shall be graduated in a manner similar to the tape.

(f) The graduation on the dip weight shall begin from its bottom and shall be carried over in such a manner that when the dip weight is attached to the tape the graduations are continuous from the weight to the tape.

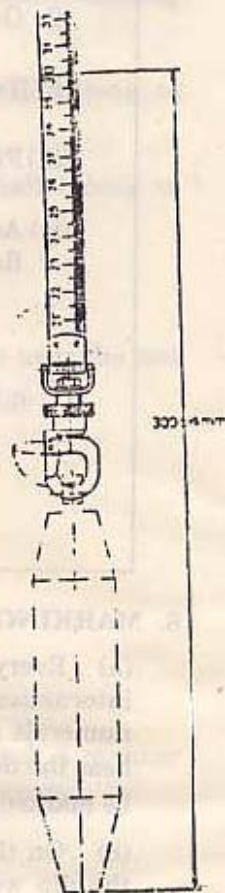
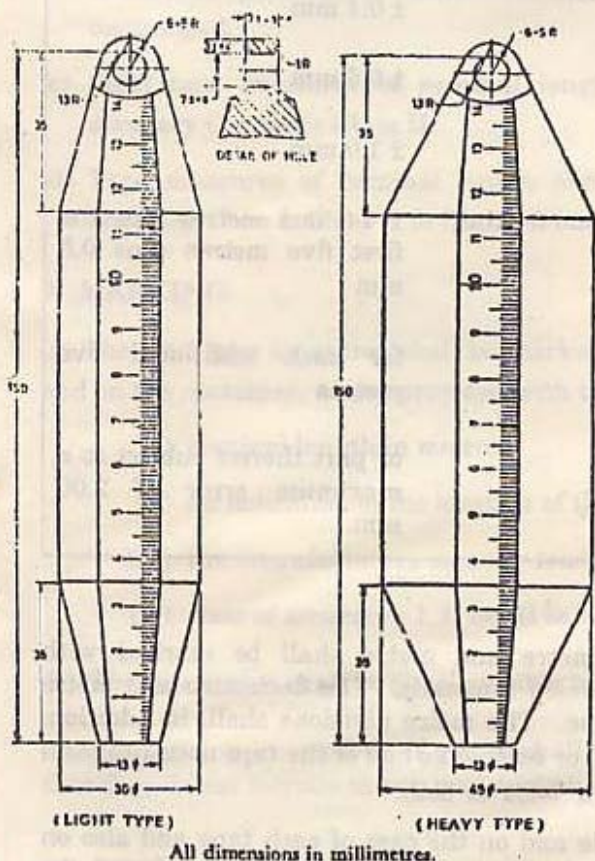

Fig-11. Light and Heavy Dip Weight

Fig-12. Swivel Hook Attachment



**7. PERMISSIBLE ERROR**

The error in the length of the tape supported on horizontal surface with a tension of 50 newtons shall not exceed the following limits :

(a) Between any two adjoining mm and cm lines	Not more than $\pm 0.2$ mm
(b) Between any two adjoining decimetre and metre	Not more than $\pm 0.4$ mm lines
(c) From zero to the points specified below :	
(i) One metre mark	$\pm 0.4$ mm
(ii) Two metre mark	$\pm 0.6$ mm
(iii) Five metre mark	$\pm 1.0$ mm
(iv) Any metre mark beyond for the first five metres	$\pm 1.0$ mm metres plus the first five metres plus 0.5 mm
	for each additional five metres
	or part thereof subject to a maximum error of 2.00 mm.

**8. MARKING**

(a) Every centimetre, decimetre and metre shall be marked with international form of Bangladeshi numerals. The decimetre and metre numerals shall be in bold type. The metre divisions shall, in addition, bear the designation 'm' or 'মি' or both. The end of the tape measure shall be marked with word 'metre' or 'মিটার' or both.

(b) On the ungraduated side and on the case of each tape and also on the dip weights, the name of trade mark of the manufacturer and the denominations shall be legibly marked. In addition, direction of winding shall also be legibly marked on the case or reel. Suitable provisions shall be made for Inspector's stamps on the dip weight and the tape.

## Schedule-XXI

(See rule-11)

Specifications for weighing instruments and measuring instruments for use in transactions of trade and commerce and limits of errors to be tolerated in verification or re-verifications.

### PART-1

#### SELF-INDICATING AND SEMI-SELF INDICATING COUNTER TYPE WEIGHING MACHINE

##### 1. DEFINITION

(a) Self-Indicating Counter Machine—A counter machine which on the application of the load to be weighed, indicates the whole of the load automatically. A typical self-indicating machine is illustrated in Fig. 1.

(b) Semi-Self Indicating Counter Machine—Counter machine which, on the application of the load to be weighed, indicates automatically only a portion of the weight of the whole load leaving the remainder to be balanced by weights or sliding poises fitted to the tare or capacity bars or by any other suitable means. A typical semi-self indicating machine is illustrated in Fig. 2.

##### 2. CAPACITIES

The self-indicating or semi-self indicating machines may be of the capacities shown in Table XV.

##### 3. GENERAL REQUIREMENTS

- (a) Self-indicating and semi-self indicating counter machine shall be so constructed as to—
- (i) provide a clear and legible indication.
  - (ii) ensure that the horizontality of the weight receptor, where provided, and the goods receptor, is maintained throughout the range of movement.
  - (iii) incorporate a suitable damping device.
- (b) The supports for the pans shall be of a suitable rigid structure. The pans may be made of any suitable material such as mild steel, stainless steel, brass or bronze, aluminium or its alloys, porcelain, enamel coated steel glass or plastic material.



- (c) The pivots, knife, edges, bearing surfaces and all points of contact, where provided, shall be made of suitable hard material and shall be so fitted as to allow free movement of the weighing mechanism.
- (d) The machine may have a balance box for minor adjustments. If a balance box is provided, it shall be permanently fixed, preferably beneath the weight pan, and shall be large enough to contain loose material to an amount up to one per cent of the capacity of the machine. No other adjusting contrivance shall be used. In case of self-indicating machines, the balance box shall be fixed below the goods pan.
- (e) The indicator scale shall be graduated into division of equal weight value and the distance between minor graduations shall be not less than—
- (i) 1.2 mm for dial indicators, and
  - (ii) 2 mm for indicators with optical projections.

One circular dials, the distance between minor graduations shall be uniform. On fan-shaped and linear dials, the distance between minor graduations may be variable but the greatest distance shall not be more than 1.2 times the smallest. The weight corresponding to the distance between the minor graduations shall not exceed the value shown in Table XV.

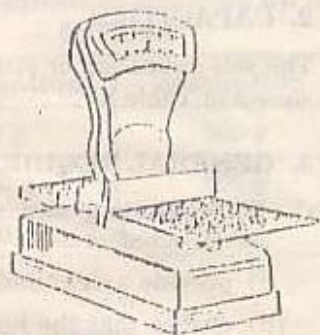

Fig-1. Self Indicating Machine

Fig. 2. Semi-Self-Indicating Machine

The extremity of the pointer shall not exceed 1 mm in width and shall not be more than 3 mm away from the graduated surface of the dial. The position of the pointer, at no load, shall be clearly indicated by the zero mark.

- (f) The value of the minor graduation of the chart expressed in units of mass, shall be in the form  $1 \times 10^n$ ,  $2 \times 10^n$  or  $5 \times 10^n$ , 'n' being a positive or negative whole number or zero.
- (g) The self-indicating and semi-self indicating machines excepting out-of-level scale, shall be provided with levelling screws and a circular bubble.

**Note** :—If there are three legs, two of them shall be provided with levelling screws and in case of four legs at least three shall be provided with levelling screws.

- (h) When tare bars are graduated they shall only permitted provided the chart capacity and the total capacity (chart plus tare bar) comply with capacities shown in Table XV.

**Note**:—When tare bars are used and are not graduated except with a zero mark, they shall not be taken into account when calculating the capacity of the machine, ungraduated tare bars shall be marked with zero.

#### 4. TESTS

- (a) All self-indicating and semi-self indicating counter machines shall be tested on a horizontal level plane.
- (b) The machines shall be tested throughout the full range of their capacity by progressively increasing the load. The permissible error at any load shall not exceed the limits specified in Table XV.
- (c) When the pans are loaded to half the capacity the weight indicated on the dial shall be correct within the permissible error, when the load is moved within a distance from centre equal to one-third of the greatest length of the pan.
- (d) When the goods pan is in the form of a scoop, the machine shall be correct to the prescribed limits of error if half of the full load is placed against the middle of the back of the scoop and the other half in any position of the scoop.
- (e) Self-indicating and semi-self indicating machines shall not be tested for sensitiveness.



## 5. SEALING

Each machine shall be provided with a plug or stud of soft metal on a conspicuous part of the beam or body to receive the stamp or the seal of the verification authority. Such a plug or stud shall be made irremovable by undercutting it or by some other suitable manner.

TABLE XV

Maximum permissible error for self-indicating and semi-self indicating counter type weighing machine.

Capacity	Maximum value of the minor graduations	Maximum permissible error at any load	
100 kg	200 g	(A) Self-indicating Machines	Inspection A weight equal to one minor graduation
50 kg	100 g		
20 kg	100 g		
10 kg	50 g		
5 kg	20 g		
2 kg	10 g		
1 kg	10 g		
500 g	5 g	(B) Semi-self indicating Machines	A weight equal to one minor graduation
200 g	2 g		
100 g	1 g		
100 kg	100 g		
50 kg	50 g		
20 kg	20 g		
10 kg	10 g		
5 kg	10 g		
2 kg	10 g		
1 kg	10 g		
500 g	5 g		
200 g	2 g		
100 g	1 g		

**PART-2****PERSON WEIGHING MACHINES****1. DEFINITION**

(a) A person weighing machine means an instrument with a weighing mechanism and with a platform to receive the person to be weighed. The weight of the person is indicated with a steelyard or any other form of indicator or by a ticket printing device.

(b) Person weighing machine of steelyard, dial and ticket printing types are illustrated in Fig. 3, 4 and 5 respectively. These drawings are illustrative only and do not specify any particular design.

**2. CAPACITY**

The person weighing machine shall have capacity not less than 120 kg capacity.

**3. GENERAL REQUIREMENTS**

(a) Platform—The maximum size of the platform shall be  $400 \times 350$  mm area. The platform shall not extend beyond the frame on any side.

(b) Steelyard (wherever provided)

- (i) The steelyard shall not have any readily removable parts except the support for proportional weights. The minimum travel of steelyard shall be 10 mm either way.
- (ii) The top and bottom of the guide of steelyard shall be fitted with non-magnetic material if these are made of ferrous material.
- (iii) When the steelyard is provided with notches, these shall be suitably protected.
- (iv) The value of the smallest division on the steelyard shall be not more than 50 g and the steelyard shall be graduated with  $5 \text{ kg} \times 50\text{g}$  divisions.
- (v) Balancing Arrangements—Where a balancing device is provided on the steelyard, the balance ball shall not be easily accessible. The balancing arrangement shall have a range not exceeding 0.5 per cent of the capacity of the machine and not less than 0.1 per cent of the capacity each way. The balancing ball shall be securely attached to the steelyard. The balancing ball shall be actuated by knurled headed bolt passing through it.



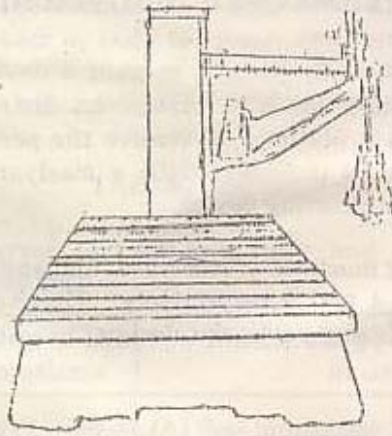

PERSON WEIGHING MACHINE STEEL YARD TYPE

Fig.-3

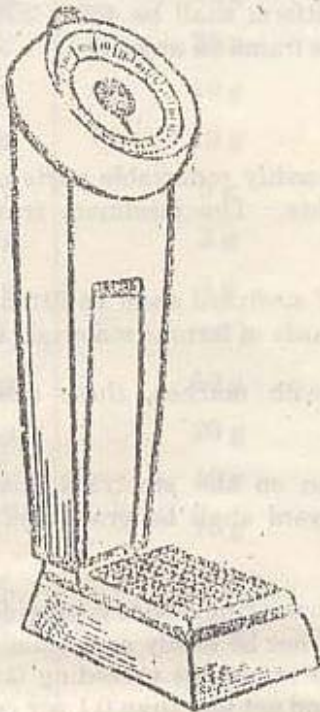
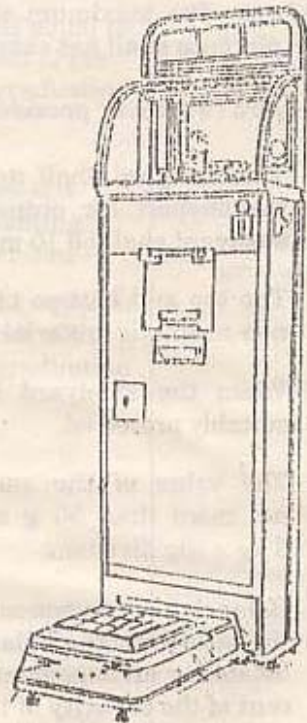
Fig.-4 Person Weighing  
Machine Dial TypeFig.-5 Person Weighing  
Machine Ticket Printing Type

- (c) In the case of person weighing machine provided with dial—
- (i) The racks and pinions shall be of suitable hard wearing material and shall be finished smooth.
  - (ii) The extremity of the pointer shall, in no position, be at a greater distance from the graduated surface of the dial than 5 mm. If the pointer is on a different plane, the extremity of the pointer shall be on graduated portion of the dial, but shall be so made as not completely obscure the graduation mark or make it difficult to read any graduation mark.
  - (iii) The dial shall be graduated reasonable into equal parts and the minimum width apart of the graduations shall not be less than 1.5 mm and the value of the smallest graduation shall not be more than 500 g.
- (d) In the case of person weighing machines provided with ticket printing device—
- (i) The racks and pinions shall be of suitable hard wearing material and shall be finished smooth.
  - (ii) The weight shall be legibly indicated on the ticket.
- (e) Proportional weights (wherever provided)—
- (i) All proportional weights shall be identified with the machine by a number or any other suitable mark of identification which shall be indelible. The counterpoise weights shall be marked with their equivalent weights in the following manner :  
১০০ কেজি or 100 kg
  - (ii) Proportional weights shall be hexagonal in shape with a slot of suitable size to allow them being placed on the counter balance.
  - (iii) The proportional weights shall be made of cast iron or brass.
  - (iv) The proportional weights shall have one rectangular loading hole which shall be undercut or tapering outside so as to hold lead securely for adjustments. The undercut hole shall be of reasonable size so as to accommodate the load required for adjustment. The surface of the lead in the loading hole shall not be less than 2 mm inside from the bottom surface of the lead in the loading hold shall not be less than 2 mm inside from the bottom surface of the weight.
  - (v) The denominations of proportional weights, shall be 1 kg., 2 kg, 5 kg or a multiple or sub-multiple by 10 or a power of 10 of any of these weights. The total equivalent value of the proportional weights shall not exceed the capacity of the machine. For the purpose of calculating total capacity, the graduation on the steelyard shall not be taken into account.



**5. TESTS**

- (a) The steelyard of the person weighing machine shall remain horizontal at no load. In case of dial type machines, the position of indicator, at on load, shall be at zero mark.
- (b) The machines shall be tested to verify the accuracy of numbered graduation up to the total capacity.
- (c) All proportional weights, where these are provided, shall be tested and than suitably sealed to prevent tampering.
- (d) Person weighing machines with the steelyard arrangements shall be tested for error at any load up to full load as well as for sensitiveness at full load. The maximum permissible errors and sensitiveness are given in Table XVI.
- (e) Person weighing machines provided with dial type indicator or ticket printing device shall be tested for errors only. No sensitiveness test shall be taken on such machines. The permissible error at any load up to full load shall not exceed the limits prescribed in Table XVI.

**6. SEALING**

The person weighing machine shall be fitted with an unremovable plug in its conspicuous part, to receive the seal of the verification authority.

**MAXIMUM PERMISSIBLE ERROR AND SENSITIVENESS FOR  
PERSON WEIGHING MACHINES**

Type of Machine	Sensitiveness when full loaded	Maximum permissible error plus or minus at any load up to full load	
		Verification	Inspection
1. Steelyard	25g	50 g	100 g
2. Dial type	..	250 g	500 g
3. Ticket issuing type	..	500 g	1 kg

**PART-3****PART-XII : BABY WEIGHING MACHINE****1. DEFINITION**

A baby weighing machine means a weighing machine with a pan to receive the baby to be weighed. A typical baby weighing machine is illustrated in Fig. 6.

**2. CAPACITY**

The machines shall have a maximum capacity of 10, 15 or 20 kg.

### 3. GENERAL REQUIREMENTS

(a) The pan for the baby shall be either an oval or a rectangular basin, or an open-ended trough of the following approximate dimensions.

	Minimum Dimension
Length	500
Width	300
Depth Basin Type	100
Through Type	125

(b) The pan shall be smooth, non-porous, readily cleanable and of adequate strength and should preferably be made of a low heat-conducting material. Wicker-work shall not be used in the construction of the pan.

(c) Counter type baby weighing machines shall be provided with hard rubber or fiber stops to prevent noise or 'jar' in the out-of-balance position.

(d) All machines shall be so constructed as to enable a direct net weighing to be obtained.

(e) Baby weighing machines of the spring-balance self-indicating or semi-self indicating types shall be fitted with efficient oscillation control devices.

(f) In spring-balance, self-indicating or semi-self indicating type of baby weighing machines the dial shall be graduated into equal parts and the minimum distance between consecutive graduations shall be not less than 2 mm. Provision of a screw for adjustment of the pointer to correct zero error shall also be provided.

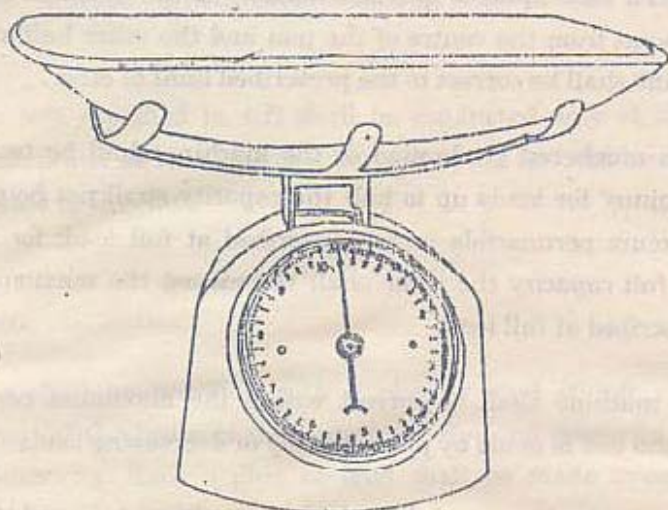

BABY WEIGHING MACHINE

Fig-6



(g) The extremity of the pointer shall not exceed 1.0 mm, in width and shall be not more than 3.0 mm away from the graduated surface the dial. The weight corresponding to the interval between consecutive graduation marks shall not exceed 50 g.

(h) The base of the machine shall be wide and heavy to avoid tilting and the position of the index, when there is no load shall be clearly indicated by a zero mark.

(i) When the weighing machine is provided with an adjustable pointer, the range of adjustment shall not exceed one percent of the capacity of the machine.

#### 4. TESTS

(a) In spring-balance, self-indicating or semi-self-indicating type of machines, the permissible error shall not exceed the weight corresponding to half the interval between consecutive graduation marks.

(b) When a load equal to half the capacity of the machine is placed at the farthest point from the centre of the pan and the other half at any position, the machine shall be correct to the prescribed limit of error.

(c) Each numbered graduation of the machine shall be tested. The error 'plus or minus' for loads up to half the capacity shall not be more than half the maximum permissible error, prescribed at full load; for loads between half and full capacity the error shall not exceed the maximum permissible error prescribed at full load.

(d) The machine shall be correct within the maximum permissible error whether the test is made by progressively or decreasing loads.

(e) For counter type machines' the sensitiveness and the maximum increasing permissible error shall be as in Table XVII.

**TABLE XVII**  
(after sealing)

Capacity	Sensitiveness when fully loaded	Maximum permissible error in excess or deficiency when fully load	
		Verification	Inspection
Kg	G	G	G
10	7.0	10.5	21
15	8.0	12.0	24
20	9.0	13.5	27

(f) The spring-balance type machine shall be loaded to its full capacity and the load maintained for a period of 24 hours after which it shall be removed. Four hours after removal of the load, the balance shall not show any permanent set. Further, when tested stated in 4(d), it shall record correct readings.

**NOTE:** The test specified in 4(f) shall be conducted only at the time of initial verification and at least one or 1 percent of the lot, whichever is more, shall be subjected to this test.

## 5. SEALING

Each machine shall be provided with a plug or stud of soft metal on a conspicuous part of the beam or the body to receive the stamp or seal of the verification authority. Such a plug or stud shall be made irremovable by undercutting it or by some other suitable method.



**PART-4**  
**KITCHEN SCALES**

**1. DEFINITION :**

“Kitchen scale” means a weighing instrument having a good pan and a graduated scale, which can be used for weighing commodities or ingredients for domestic purposes.

**2. CAPACITY :**

The kitchen scales shall have the following capacities :  
500g, 1 kg, 2 kg, 5 kg and 10 kg.

**Note :** The capacity of a kitchen scale shall not, in any case exceed 10 kg.

**3. GENERAL REQUIREMENTS**

(a) The body, the pan or scoop and components of the kitchen scale shall be constructed of suitable quality steel, non-ferrous metal or shock absorbing plastic material, sufficiently strong to withstand normal use and capable of being easily cleaned. All steel parts shall be suitably protected to prevent rusting but the protective coating shall not be deleterious to health.

(b) The pan or scoop shall be easily removable and shall be smooth and capable of being cleaned easily. It shall not tip over when evenly filled. The scoop, if provided, shall have cubic capacity of not less than one liter for kitchen scales having capacities 1 kg and above and not less than one-half liter for kitchen scales having capacities less than 1 kg. It shall incorporate devices for pouring out easily the commodities weighed or measured in it.

(c) The scoop may also be provided with volume indications and such indications need not be verified.

(d) The indicating device shall be divided into graduations representing equal weights. The distance between the lines representing the minimum graduation shall be :

(i) not less than 1.2mm, if the graduations are read directly,

and

(ii) not less than 2 mm, as it appears, after magnification, if magnifying device is provided.

(e) The weight corresponding to the minimum graduation shall not exceed one percent of the capacity.

(f) The value of graduation shall be indicated only in metric unit and shall be equal to a number of kilograms expressed in one of the following formulae :

$$1 \times 10^n, 2 \times 10^n \text{ or } 5 \times 10^n$$

where 'n' represents either zero or a whole number, positive or negative.



- (g) The total number of graduations shall not be less than 100 but not more than 1000.
- (h) The dial and pointer may be enclosed by a suitable lens to increase legibility of the reading.
- (i) The graduation lines shall be of reasonably uniform thickness throughout their length.
- (j) Every fifth graduation line shall be longer and at least every tenth graduation line shall be numbered.
- (k) The pointer may preferable be in a contrasting colour to the graduation lines and the dial. The pointer may meet the graduation lines and may cover but not completely obscure them.
- (l) When the graduation commences at a fixed load, the position of the pointer, when there is no load, shall be clearly indicated by a zero mark.
- (m) The scale shall be provided with a zero setting device except where auto zeroing has been provided.
- (n) The scale shall be provided with a device to prevent the effect of any overloading which may adversely affect its metrological qualities.

#### 4. TESTS :

- (a) The scale shall be tested on a hard flat and level surface.
- (b) The deferent on return to zero, immediately after removing a load, equal to the capacity, kept on the instrument for half an hour shall not exceed half the value of the minimum graduation. At least one for one percent of the load which ever is more, shall be subjected to this test.
- (c) The minimum error at any load up to full capacity shall not exceed the value corresponding to the minimum graduation at the time of initial verification.
- (d) When a weight equal to a quarter of the maximum capacity is moved from the centre of scoop or pan in any direction to a distance of 50 mm, the scoop or pan shall not trip or topple.

#### 5. SEALING

Kitchen scales shall be provided with a suitable sealing arrangement to receive the seal of verification authority.



**PART-5****BATHROOM SCALES****1. GENERAL**

(a) This part deals with the requirements of bathroom scales which are intended to be used for taking the weights of individual persons in a private household.

(b) Bathroom scales shall not be used where many persons are to be weighed frequently such as in schools, hospitals, clinics or by doctors who undertake medical examination for purposes of life insurance or issuing certificates of health etc.

(c) Bathroom scales shall be verified before sale and may be reverified if the user so desires.

**2. DEFINITION**

A bathroom scale means a weighing scale with a platform to receive the person to be weighed, a weighing mechanism and a rotating dial or an indicator for automatic indication of the weight.

**3. CAPACITY**

Bathroom scales shall have a capacity of not less than 120 kg.

**4. GENERAL REQUIREMENTS**

(a) The platform, base and the components shall be constructed of suitable quality steel, non-ferrous metal or shock-absorbing plastic material sufficiently strong to withstand normal use. All steel parts shall be suitably protected to prevent rusting.

(b) The indicating device shall be divided into graduations representing equal weights. The distance between the lines representing the minimum graduation shall be :

(i) not less than 1.25 mm, if the graduation are read directly;

and

(ii) not less than 2 mm, after magnification if a magnifying device is provided.

(c) The weight corresponding to the minimum graduation shall not exceed one kilogram.

(d) The value of graduation shall be indicated in metric units and shall be equal to a number of kilograms expressed by one of the following formulae :

$$1 \times 10^n, 2 \times 10^n \text{ or } 5 \times 10^n$$

where  $n$  represents either zero or a whole number, positive or negative.

(e) The total number of graduations shall not be less than 100 but not more than 1000.

(f) The dial and pointer may be enclosed by a suitable lens to increase legibility of the reading.

(g) The graduation lines shall be of reasonably uniform thickness throughout their length.

(h) Every fifth graduation line shall be longer and at least every tenth graduation line shall be numbered.

(i) The scale may be provided with a zero setting device capable of being operated from outside the scale. The range of adjustment of the zero setting device, if provided, shall not exceed 5 kg.

(j) The scale shall be provided with a device to prevent the effect of any overloading which may adversely affect its metrological qualities.

## 5. TESTS

(a) The scale shall be tested on a hard, flat and level surface.

(b) The scale shall be initially loaded to an indication of at least 50 kg and that load shall be maintained for about half an hour. The difference on return to zero immediately after removing the load shall not exceed half the value of the minimum graduation.

(c) After setting the scale at zero after the test in (b) above a pressure of about 5 kg shall be exerted on the platform by hand and then released. If the scale does not return to zero, the scale shall again be set at zero graduation and the procedure repeated until it returns to zero on releasing the pressure.



- (d) Test loads, increasing in steps of 20 kg and evenly distributed over area of the platform, shall be carefully applied up to the full capacity of the scale. The test shall be repeated to provide two readings at each increment of the test load. The arithmetic mean of the two readings at each test load shall not be inaccurate by more than the maximum permissible error for that load.
- (e) The difference between the results of several repetitions of the same test load shall not exceed the maximum permissible error for that load.
- (f) Five percent of one lot of bathroom scales shall be initially verified by placing a test load equal to the full capacity of the instrument, for a period of about 8 hours. The difference between the indication obtained immediately after depositing the load and the constant indication obtained 8 hours later shall not exceed the maximum permissible error for that load.
- (g) When tested for model approval, the bathroom scale shall not show an error exceeding twice maximum permissible error, after being subjected to 2000 weighing at full load. These weighings shall be made in quick succession but shall be limited to not more than 20 weighings per hour.
- (h) The standard test weights used for the verification of the scale shall not be inaccurate by a relative error of more than 0.3 times the maximum permissible error of the scale for the given load.

## 6. MAXIMUM PERMISSIBLE ERROR

The maximum permissible errors shall be as specified below :

Test load	Maximum permissible error at initial verification
From 0 kg up to and including 50 kg	+ 500 g
Above 50 kg	± 1 kg

**Note** :—The maximum permissible errors at the time of re-verification, if any, shall be double of those specified in the above table.

## 7. SEALING

Bathroom scales shall be provided with a suitable place to receive the seal of verification authority.

**Schedule-XXII**

(See rule-13)

**Part-1****TANK CALIBRATION**

All kinds of storage tanks as specified in sub-rule (3) and such other tanks as the Director General may specify in this behalf, shall be calibrated in site in addition to any preliminary test in the user's premises. Such calibration should be followed by verification and certification by the Director General or Director or Deputy Director of that area.

**OUTLINE OF MEASUREMENT :**

Calibration of tanks with scale.

**OBJECTS OF VERIFICATION :**

1. Tanks with volumetric scale rod.
2. Tanks with gauge glass.
3. Tanks with overflow.
4. Tanks with scale on the inside surface.
5. Tanks with float.
6. Tanks with scale rod and volumetric chart.
7. Tank lorries with volumetric scale rod.
8. Tank lorries with gauge glass.
9. Tank lorries with scale on the inside surface.
10. Tank lorries with scale rod and volumetric chart.
11. Tanks. ♀
12. Lighter age.
13. Burge.
14. Other reservoirs.

If any manufacturer or user of water or any other liquid reservoir or storage tank intends to calibrate or verify, BSTI may calibrate or verify after receiving proper fees etc.



**VALIDITY PERIOD :**

- (a) For all kinds of storage tanks : 5 years.
- (b) For tank lorry : One year.

**Minimum quantity :** The minimum quantity is the quantity which can be measured with an accuracy within  $\pm 0.05$  percent.

**VERIFICATION TOLERANCE.**

The permissible error in excess or in deficiency for verification, re-verification or inspection, which cannot exceed 0.05 percent of the indicated quantity.

**VERIFICATION METHOD.**

The minimum quantity which can be measured with an accuracy within  $\pm 0.05$  percent (referred to as the minimum quantity hereinafter) shall be clearly indicated.

The level on the tank shall be installed. However, tanks installed on freight cars, automobiles and ships, tanks used in a stationary condition and tank lorries with scale shall be excluded.

The construction of the part of the tank (including these installed on ships) where the scale is provided shall be such that the position of the meniscus moves more than 1 mm when a quantity corresponding to the acceptance tolerance which conforms to the minimum quantity is added or deducted. However, this must move more than 2 mm in case of tanks with volumetric scale rod, tanks with scale on the inside surface, tanks with scale rod and volumetric chart. Also this move must be more than 4 mm in the case of tanks with scale installed on ship.

Verification shall be carried out by volumetric method.

**VOLUMETRIC METHOD :**

Water charged into the tank to be verified and then water discharged from the tank is measured with a reference tank or water charged into the tank measured with a reference tank.

**STAMPING :**

The verification stamp shall be placed either on a metal label or disc permanently attached to the tank. Sticker stamp may be attached for stamping of water or liquid reservoir.



**PART-2****CALIBRATION OF VEHICLE TANKS FOR PETROLEUM PRODUCTS  
AND OTHER LIQUIDS****1. DEFINITIONS**

(a) **Vehicle Tank.**—An assembly used for measurement and delivery of liquids comprising a tank which may or may not be sub-divided into compartments, mounted upon a vehicle together with its necessary piping, valves meters etc.

(b) **Compartment.**—The entire tank, when this is not sub-divided; otherwise any one of these sub-divisions of a tank designed to hold liquid.

(c) **Calibrations.**—Verification and stamping of the capacity of the vehicle tank or its compartments.

(d) **Dip Stick.**—A square or rectangular metal bar of brass or any other suitable hard material used to determine the depth of the liquid in the tank.

(e) **Ullage Stick.**—A T-shaped metal bar of brass or other suitable material used to determine the depth of the level of liquid from the proof level.

(f) **Ullage Indicator.**—A device bolted to the inside of a manhole neck ring with the indicator set to any desired level to which liquid in the tank is required to be filled.

(g) **Proof level.**—Reference level to which all depth measurements shall be related.

(h) **Dip pipe.**—A pipe rigidly attached at the top of the tank extending vertically downward up to approximately 15 cm from the bottom of the tank. The pipe shall have perforations at the top above the maximum liquid level.

**2. TESTING MEDIUM**

(a) **Compartment Testing.**—Water or other appropriate liquid shall be used as a testing medium in determining the capacity of vehicle tank compartment.

(b) **Meter Testing.**—A vehicle tank meter shall be tested with a liquid of the same character or of approximately the same viscosity as the liquid to be measured through the meter.



### 3. EQUIPMENT AND TOOLS

The following equipment and tools are required for calibration of vehicle tank.

- (a) **Proving Measures.**—When available, shall be checked for accuracy against an appropriate working standard measure.
- (b) **Calibrated Bulk meter.**—An accurate meter fitted with a preset valve, air eliminator and strainer, which has been checked for accuracy against an appropriate working standard measure.
- (c) A set of standard commercial measures.
- (d) Other equipment and tools viz.; hose pipe, scribe, punch, try square, tyre pressure gauge, hammer etc.

### 4. CALIBRATION PROCEDURE

- (a) Vehicle tanks used as measures shall be calibrated as capacity measures. In the case of meter equipped tanks the meter shall be treated as a separate measuring instrument for purpose of calibration.
- (b) The compartment capacity or capacities shall be taken as including the capacities of the delivery lines, leading from the emergency, safety or master valve to the outlet valve (discharge valve) provided that in the case of vehicle compartment valve, the compartment capacity or capacities shall be taken as excluding the capacity of the delivery pipeline. A notice shall be prominent exhausted on the vehicle tank indicating clearly and indelibly the following :—

Marked capacity includes capacity of delivery line;

**OR**

Marked capacity excludes capacity of delivery line (as the case may be).

The safety or master valve shall be positioned at the lowest point of outlet from the compartment.

- (c) The proving measure of bulk meter should be mounted on an overhead gantry or a separate framework in a convenient position above a firm and level platform, preferably of concrete on which the vehicle stand during calibration.



- (d) The vehicle shall be placed in a level position before commencing calibration as the accuracy of calibration depends on the level of the tank, the sequence in which compartments are calibrated should be such as to minimise unequal spring deflection on the axles of; the vehicle.
- (e) The front and rear tyres of the vehicle should be at the correct pressures. The tyres should be inspected for wear which should be reasonably even and there should not be excessive difference in the tread between the front set of tyres and the rear set the time of calibration.
- (f) The interior of the compartment should be inspected and cleaned where necessary.
- (g) Before starting calibration the pipelines, outlet valves and other connections shall be tested against leakage by partially filling and draining each compartment in turn through the outlet valve. During the process sufficient quantity of the testing medium should be introduced inside the compartment to wet the internal surface of the tank and pipelines.
- (h) After taking the precautions mentioned above, the compartment to be calibrated shall be filled with appropriate proving measures or bulk meters to the marked capacity of the compartment with the delivery lines leading to the outlet valve full or empty as provided in (b) above. The dip/ullage mark shall be taken carefully and the line shall be cut on the dip/ullage mark shall be taken carefully and the line stick at right angles to the axis with the help of try-square and scribe. If an ullage indicator is used, it shall be correctly set and sealed.
- (i) A mark shall also be made on the dipstick to indicate the "proof level". In the case of ullage stick, the distance from the ullage point to the T-joint shall be marked on the stick.

**NOTE** :—The sequence for calibrating compartments should be sequence of filling them. The sequence of discharge shall be in the reverse order to that of filling.

- (j) Each compartment should be left full before proceeding to the next in sequence.



## 5. MAXIMUM PERMISSIBLE ERROR

(a) Proving measures shall have the following capacities and shall be adjusted within the following permissible errors :—

Capacity, Liters	Permissible Error, Milliliters ( ± )
50	50
100	100
200	200
500	500
1000	1000
1500	1500
2000	2000
5000	5000

(b) The maximum error for vehicle tank compartments shall be 0.05 percent in excess of the marked capacity of the compartment.

## 6. MARKINGS

(a) The vehicle shall have a brass plate riveted in a prominent position on it to receive the Inspector's stamps. The brass plate shall bear the following particulars : name of owner of vehicle, vehicle registration number and the serial number and capacity of each compartment. Space should be provided on the plate for the Inspector's stamps. A simple design for a plate is shown.

(b) The capacity of compartment shall be indelibly marked on the manhole cover of the compartment and also painted on each side of the compartment so that it is clearly visible. If there are more than one compartment, then each compartment shall have its capacity marked separately as above and the compartment numbered serially. The number of the compartment shall also be marked on the discharge valve pertaining to the compartment.

(c) The vehicle registration number as well as the capacity of the compartment shall be indelibly marked on the dip/ullage stick at the top end. If there is more than one compartment, the different faces of one dip stick may be used for markings and each face shall bear the vehicle number, the serial number of the compartment, the proof and dip lines of that compartment and the capacity of the compartment.

Name of the Company

Vehicle Tank No. ....

Compartment Number	Compartment Capacity (in liter)	Space for Inspector's Stamp

**NAME PLATE**



**PART-3****METHOD FOR CALIBRATION OF VERTICAL OIL STORAGE TANKS****1. SCOPE**

This part prescribes methods for calibration of vertical tanks by strapping and internal measurements. These tanks are meant for bulk storage of petroleum and liquid petroleum products.

**2. CONDITIONS FOR MEASUREMENTS**

(a) All data and methods, whereby measurements are obtained, necessary for the preparation of calibration tables, shall be in accordance with sound engineering principles.

(b) When drawings for the tank are available, all measurements shall be compared with those obtainable from the drawings and measurements showing discrepancies greater than the tolerance specified in 9(c), shall be verified. A similar process of check shall be employed in all cases where reliable information beyond the measurements taken, is available.

(c) Measurements shall be taken only after the tank has been filled at least once at its present location with the product to be stored to its working capacity or with water to its equivalent height and such product or water has been held in the tank for at least 24 hours to allow for setting.

**3. INTERRUPTED MEASUREMENTS**

If the calibration of a tank is required to be interrupted, it may be resumed with minimum delay, without repetition of work previously completed provided that :

- (i) there is no major change in equipment and as far as possible, no change in personnel;
- (ii) all records of work done are complete and legible; and
- (iii) same hydrostatic head as before is maintained in the tank.

**4. DESCRIPTIVE DATA**

(a) Complete descriptive data shall be entered on the Tank Measurements Record Form being used. A recommended record form is shown in Table 1.

(b) Supplemental pencil sketches or notations each completed, identified, dated and signed, shall form an important part of field data. These shall be made to indicate typical horizontal and vertical joints, number of plates per course (ring), locations of course (rings) at which thickness of plates changes, arrangement and size of angles of top and bottom of shell, location and sizes of pipes and manholes, dents and bulges in shell plates, direction of lean from vertical method used in by-passing a large obstruction, such as clean-out box or insulation box located in the path of a circumferential measurement, location of tape path, location and elevation of possible datum plate and all other items of interest and value which will be encountered.

Table-1

Recommended record form for measurements of  
Vertical tanks [Clause 4(a)]

Report No.....	Data .....
Tank No .....	(Old Tank No.) .....
Owner's Name .....	
Plant or Property Name .....	
Location .....	
Manufactured by .....	
Erected by .....	
Prepare .....	Copies .....
Increments in .....	
Fraction to .....	Table form or Size Desired .....
Height : Shell .....	Gauging .....
Type of Roof .....	Weight of Floating Roof .....
Tank Contents .....	Name .....
Avg. Liquid Temp, °C .....	
Gauge .....	
cm or mm inn age to Shelf Floor or Outage :	
Hydrometer Reading .....	at .....
°C .....	
Sample Temperature	
Gauging Reference Point to Top of Top Angle .....	
cm or mm .....	
Normal	
Service .....	
Shell Circumference or Diameters :	
A.....	D.....
G.....	
B.....	E.....
H.....	
C.....	F.....
J.....	





**Bottom Course (Ring) Shell Connection :**

No.	Description	Elevation, Top of Floor to Bottom of Connection
1		
2		
3		
4		

Type of Bottom ..... Height of Crown .....

Deadwood and Remarks (Use reverse side if necessary) :

Description	No.	Size	From	To

Thickness ..... Measurements by .....

Amount of Tank Lean from Vertical

Circumference Tape Used ..... Dated check at .....

Tank measured by ..... for .....



Deadwood and Tank Bottom - Use separate sheets. For each piece or item of deadwood record description, size, number of occurrences and location related to other height measured data recorded.

Explanatory Notes (such as type of bottom, height or depth of crown, etc.)

(c) All measurements made by the tank calibrator shall be recorded on site and shall not be subjected to subsequent correction.

## 5. DEGREE OF ACCURACY

In order to obtain maximum obtainable accuracy calibration tables, adjustments for effects of the following variables shall be incorporated in the tables :

- (i) Expansion and construction of steel tank shell due to liquid heads,
- (ii) Tilt from upright position, and
- (iii) Tank bottoms that are irregular in shape.

**Note :** The degree of accuracy desired or required in the completed calibration table for a specific tank shall be the governing factor in determining the procedure to be followed.

## 6. EXPANSION AND CONTRACTION OF STEEL TANK SHELLS DUE TO LIQUID HEAD AND TEMPERATURE

These effects shall be eliminated by strapping the tank when it is at least two-thirds full with water or approximately full with the product [see also 2(c)]. The strapping record shall include water or product level from a known reference point, temperature of the tank contents and that of adjacent air.

**SECTION I – CALIBRATION BY STRAPPING****7. GENERAL**

- (a) This method is based on the measurement of external circumferences which are subsequently corrected to yield the true internal circumferences.
- (b) Circumferences shall be measured under conditions of liquid head as given under 2(c) and 6.
- (c) The stipulated number of external circumference measurements, together with the subsidiary measurements, where necessary, to correct for deviation of the tape from the true circular path shall be obtained as described under 9.
- (d) An internal diameter may be measured at approximately the same height as that at which a circumference has been measured, if verification of that circumferential measurement is desired.
- (e) It may be necessary in practice to refer all tank dips to a datum point other than the datum point used for the purpose of tank calibration. If so the difference in level between these datum points shall be determined either by normal surveying methods or by other suitable means.
- (f) The overall height shall be measured, using dip-tape and dip-weight, from the dipping datum point to the reference point (the dipping reference point) on the dip hatch. This overall height shall be recorded and marked on the tank at the dip hatch.

**8. EQUIPMENT**

- (a) Steel Tapes – Shall comply with the specifications under Part III of the Fifth Schedule. The tape shall be greased well before use.



- (b) **Spring Balance-Reading** up to 10 kg. with 0.1 kg, graduations, for measuring the tension applied to the tape. It is preferable to have two balances. Spring balance shall comply with specifications given under part VI of the sixth schedule.
- (c) **Step over:** The step-over is a frame holding two scribing points rigidly and at such a distance apart as meets the conditions of use laid down under 9 (d). The frame may be constructed of wood; it should be painted if required. This is used to correct deviation of the tape from its normal circular path, namely passing over fittings or joints between plates.
- (d) **Dip-Tap and Dip-Weight:** Complying with the specification given under Part III of the Fifth Schedule.
- (e) **Loops and Cords:** One or more metal loops which can slide freely on the tape and to which are attached two cords each of sufficient length to reach from the top of the tanks to the ground. The tape is positioned and its tension evenly distributed by passing these loops around the tank.
- (f) **Accessory Equipment:**
- (i) Rope
  - (ii) Hooks
  - (iii) Safety belts
  - (iv) Ladders
- (g) **Miscellaneous Equipment:**
- (i) Steel Rule
  - (ii) Sprit Level
  - (iii) Awl and Scriber
  - (iv) Marking Crayon
  - (v) Record Paper
  - (vi) Plumb Line
  - (vii) Dumpy Level
  - (viii) Positive Displacement Bulk Meter



## 9. CIRCUMFERENCE MEASUREMENT

### A. Strapping Levels.

Circumference shall be measured by a minimum of two strapping per course (ring) at the following levels:

#### (a) For riveted tanks

- (i) At 7 per cent to 10 per cent of the height of exposed portion of each course (ring) above the level of the top of the bottom angle iron of the tank and above the upper edge of each horizontal overlap between courses (rings) (see A of Fig. 1) and
- (ii) At 7 per cent to 10 per cent of exposed portion of each course (ring) below the lower edge of each horizontal overlap between courses (ring) and below the level of the lowest part of the top angle iron of the tank (see B of Fig. 1).

#### (b) For welded tanks

- (i) Two levels (see A and B of Fig. 2), the upper and the lower levels, at the top and bottom of courses (rings) shall be 20 per cent of the height of the exposed portion of the respective course (ring) away from the angle irons or seams.
- (ii) Circumferential tape paths, having been located at elevations as under (a) above shall be examined for obstructions and type of vertical joints. Projections of dirt and scale shall be removed along each path.
- (iii) Occasionally, some feature of construction such as manhole or insulation box, may make it impracticable to use a circumference evaluation at the prescribed location. If the obstruction can be spanned by a step-over then the circumference shall be measured at the prescribed elevation, using a suitable method given under 9 (d). If the obstruction cannot be conveniently spanned by a step-over, then a substitute path located nearer to the centre of the course (ring) may be chosen. The strapping record shall include the location of the substitute path and reason for the departure.
- (iv) The type and characteristics of vertical joints shall be determined by close examination in order to establish the method of measurement and equipment required. If the tape is not in close contact with the surface of the tank throughout its whole path owing to the vertical joints a step-over shall be applied so that a correction may be calculated to adjust the gross difference for this effect.



**(B) Strapping Procedure**

- (i) The tank shall be strapped by either of the methods described under (ii) and (iii) below. In either case a tension of  $4.5 \pm 0.5$  kg shall be applied to the tape and, if necessary transmitted throughout its length by suitable means, namely by means of metal loops sliding freely on the tape, the loops being passed around the tank by operators with the aid of light chain or cords.

The tape path shall be parallel with the circumferential seams of the tank.



Fig-2 LAP WELDING

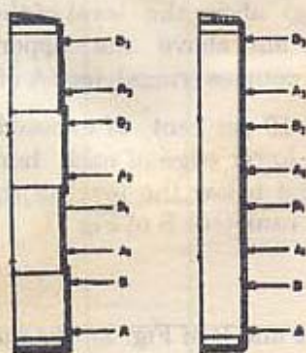

Fig-3 BUTT WELDING

RIVETED Fig-1

Locations of Measurements of Welded Tank

- (ii) If the tape to be used is not long enough to encircle the tank completely, then after the level of the tape path has been chosen, fine lines shall be scribed perpendicular to this path to allow the circumference to be measured in sections. The scribed lines shall be drawn in the middle circumferential third of any plate at such distances as will ensure that the whole of the length of the tape used is under the observation of one or other of the calibrators. Subject to the conditions under 9 (a) (iii) and 9 (a) (iv) the external circumference of the tank is then the sum of the lengths between the scribed lines.
- (iii) If the tape to be used can encircle the tank completely, then after the level of the tape path has been chosen, the tape is passed around the circumference and held so that the first graduated centimetre lies within the middle circumferential third of any plate. The other end of the tape shall be brought alongside. The tension is then applied through the spring balance and transmitted throughout the length of the tape.
- (iv) After a circumference has been measured (see iii above), the tape shall be shifted a little around the tank, brought to level and tension as above, and the reading repeated. The final reading shall be the arithmetic average of the readings.



**(C) Tolerances:**

Measurements shall be read to the nearest 1 mm and within the following tolerances when readings are taken at the same point:—

Circumference	Tolerance
Up to 30 metres	± 2 mm
Over 30 and up to 50 metres	± 4 mm
Over 50 and up to 70 metres	± 6 mm
Over 70 and up to 90 metres	± 8 mm
Over 90 metres	± 10 mm

**(D) Step-over:**

(i) If the tape crosses obstructions, such as projections deformities, fittings or lapped joints, it will deviate from a true circular path and an erroneous circumferential measurement will result. In order to avoid such errors a 'step-over' is used to measure the correction to be applied for such obstructions.

(ii) **Construction:** A step-over is a frame rigidly holding two scribing points, and of such dimensions that the points may be applied to the tape well clear of the obstruction and of its effects on the tape path, while the frame itself does not touch either the obstruction or the tank shell. Rigidity of construction is essential; suitable designs are illustrated in Fig.3.

**(iii) Use of Step-over:**

(a) For obstructions, the strapping tape shall be stretched as if in measurement of a circumference on the tank which is being calibrated, but not within 30 cm of any horizontal seam. The scribing points shall then be applied to the tape near the middle of a plate where the tape is fully in contact with the tank surface. The length between the points, as measured on the curved tape, is then read off as closely as possible, fractions of tape division being estimated. The readings shall be repeated on a minimum of two and maximum of four plates equally spaced around the circumference, and the average of the results taken, as the step-over will vary with the tank diameter and the course concerned since they are made on surface differently curved.



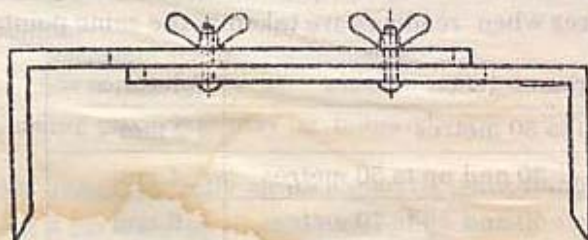

FIG. 4 -STEP-OVER

- (b) With the tape still in position and under the tension used in strapping, the step-over shall be applied to the tape on either side of each obstruction lying on the tape path, and readings shall be taken of the lengths of tapes included between the scribing points. All step-over readings shall be recorded for subsequent use in calculation.
- (c) Care shall be taken in placing the instrument in a truly level position at each obstruction to avoid distortions in circumferential path. In the case of a step-over of relatively long space, the use of a spirit level is recommended as an aid in determining its correct position before scribed marks are struck off on the places.
- (d) When the butt-strap or lap joints, or tank shell include rivets or other features which exert uneven effects on the resultant void between tape and tank from joint to joint, then a step-over will be required. The span of the instrument should be measured prior to use in accordance with (a) above. The two legs shall be separated by a distance sufficient to span each void between tape and shell encountered. The legs shall be of sufficient length to prevent contact between the interconnecting member and the tank plate or obstruction. Stretch the tape over the joints and place the step-over in position at each location of void between tape and shell, completely spanning the void so that the scribing points contact the shell at an edge of the tape. The length of tape encompassed by the scribing points, with the tape maintained in proper position and tension, should be estimated to the nearest 0.5 mm. At each step-over location, therefore, the difference between the length of tape encompassed by the scribing points and the known span of the instruments is the effect of the void, at that point, on the circumference as measured. The sum of such differences in any given path, subtracted from the measured circumference, will give the corrected circumference.



## 10. SHELL PLATE THICKNESS

- (a) Where the type of construction leaves the plate edges exposed, a minimum of four thickness measurements shall be made on each course (ring) at points approximately equally spaced about the circumference. The arithmetical average of the measurements for each course (ring) shall be recorded; all thickness measurements, properly identified, shall be noted on supplemental data sheet which shall form a part of the measurements record. Care shall be taken to avoid plate thickness measurements at locations where edges have been distorted by caulking.
- (b) Where plate edges are concealed by the type of construction, the strapping record shall be marked 'not obtainable at tank'. Alternately, plate thickness measurement may be obtained as described under (c) below.
- (c) Plate thickness measurements obtained before or during construction and recorded on a properly identified strapping record may be acceptable. In the absence of any direct measurements of plate thickness obtained and recorded before or during construction either those shown on the fabricator's drawings may be accepted and so identified in the calculation records or any other practicable method may be used for measurements of plate thickness.

## 11. VERTICAL MEASUREMENTS

- (a) A tape shall be suspended internally along the wall of the shell from the top curb angle to the bottom course (ring) and the height of the course (ring) measured to the nearest millimetre. The difference in height between the datum plate at which dip is taken and the bottom course (ring) shall be measured and the headings of the course (ring) height shall be transferred to the datum plate by applying the correction (see Fig-4).

**Example:** In Fig-4, the difference between bottom course (ring) and datum plate is  $152 - 150.5 \text{ cm} = 1.5 \text{ cm}$ . Applying this correction the corrected height of the course (ring) at

B-307.5cm

C-468.5cm

D-623.5cm

E-798.5cm



- (b) When it is inconvenient to measure the course (ring) heights internally, then they shall be computed from external measurements, due allowance being made for the effect of horizontal seam overlaps. The heights obtained shall be the vertical distance, measured to the nearest 5mm, between successive edges of the courses (ring) as exposed internally in the tank. For this purpose, in the cases of lap joints, it will be necessary to determine the width of lap in each course (ring).

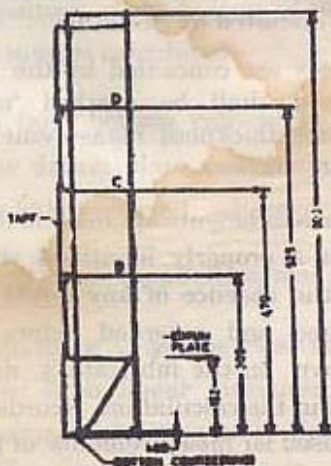

FIG-5

- (c) If necessary, heights at more than one vertical around the tank may be taken, and for each course (ring), an average of the results obtained.

## 11. DEADWOOD

- (a) Any fitting which adds to or subtracts from the capacity of the tank is called deadwood. Deadwood shall be accurately nearest millimetre in order to permit:
- Adequate allowance for volumes of liquid displaced or admitted by the various parts, and
  - Adequate allocation of the effects at various elevations within the tank.
- (b) Deadwood should be measured, if possible, within the tank. Dimensions shown on the builder's drawings may be accepted if actual measurement is impracticable.



- (c) Measurements of deadwood should shown the lowest and highest levels, measured from the tank bottom adjacent to the shell, at which deadwood affects the capacity of the tank. Measurements should be in increments which permit allowance for its varying effect on tank capacity at various elevations.
- (d) Large deadwood of irregular shape may have to be measured in separate sections suitably chosen.
- (e) Work sheets on which details of deadwood are sketched dimensioned and located, should be clearly identified and should become part of the strapping record.
- (f) For variable deadwood, such as nozzles and manholes, encountered in the bottom one or two courses (rings) of the tanks, an average deadwood correction shall be made.

### 13. TANK BOTTOMS

#### (a) Flat Type

- (i) Tank bottom which are flat and stable under varying liquid loads will have no effect on tank capacity depressed on the basis of geometric principles.
- (ii) Where tank bottom conditions of irregularity, slope and instability exist, and where correct capacities cannot be determined conveniently from linear measurements alone, it shall be necessary to resort either to liquid calibration to floor survey.
- (iii) **Liquid Calibration:** The procedure in carrying out the liquid calibration is to fill into the tank quantities of known volume of water or other non-volatile liquid until the datum point is just covered and the total quantity recorded. Additional quantities shall then be added until the highest point of the bottom is just covered. This may be done in one or more stages as desired and the dip reading and quantity at each stage recorded. It is convenient for dip readings to be taken at intervals of approximately 3 cm, the successive intervals not necessarily being identical. This liquid may conveniently be measured into the tank by a positive displacement meter which should be previously calibrated for the liquid and rate of flow to be used. Alternatively, an accurately calibrated measure or tank may be used.



- (iv) Volumes for the tank calibration table above this elevation shall be computed from linear measurements.
- (v) **Floor Survey.** The floor survey consists in recording levels of the floor by means of a dumpy level with the help of the spirit levels, the cross sections of the entire floor may be computed. The levels when plotted will define the profile and the geometric pattern of the bottom of the tank. Thus the capacity of the tank may be calculated.
- (vi) During the tank bottom calibration the difference in height between the datum plate and the bottom of the bottom course (ring) should be recorded, wherever possible.

(b) Conical, Hemispherical, Semi-ellipsoidal and Spherical Segment.

Tank bottoms conforming to geometrical shapes have volumes which may either be computed from linear measurements or measurements by liquid calibration by incremental filling or by floor survey, as desired. Any appreciable differences in shape affecting the volume, such as knuckle, radii, etc., shall be measured and recorded in sufficient detail to permit computation of the true volume.

#### 14. MEASUREMENT OF TILT

Measurements shall be taken to determine the amount, if any, by which the tank is tilted. This can conveniently be done by suspending a plump line from the top angle and measuring the offset at the bottom angle (see Fig.5). Alternatively, if the tank bottom is being calibrated by floor survey with a dumpy level as in 13 (a) (v), the tilt can be estimated by taking reading along the periphery of the tank bottom. Also, if a liquid calibration of the bottoms is being made as outlined in 13 (a) (iii), the tilt can be determined by taking measurements from the surface of the liquid to the bottom of the tank. In any of these methods, a sufficient number of measurements shall be taken at different points on the circumference to determine the maximum offset.



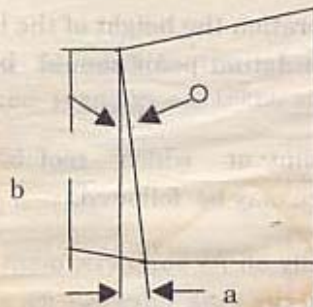

FIG. 5

## 15. FLOATING-ROOF TANKS

- (a) All calibration measurements shall be made exactly as for tanks with fixed roofs.
- (b) Liquid Calibration for Floating-Roof Displacement:
  - (i) Corrections for floating-roof displacement arising from the weight of the roof and the deadwood associated with it shall be allowed or in the calibration measurement.
  - (ii) If the weight of the floating-roof is accurately known, correction for the displaced liquid may be applied knowing density and temperature of the tank contents at the time of determining the actual inventory.
- (c) Alternately, displacement due to the floating-roof and deadwood may be determined by admitting oil to the tank until the dip reading is just below the lowest point of the roof. Known quantities accurately determined (for example by flow meter or delivery from a portable tank or measure which has been accurately calibrated) are then admitted to the tank and the corresponding dip readings recorded at a number of suitable intervals until the point is reached when the roof just becomes oil borne. Record the density and temperature of oil used.
  - (i) It is advisable to use a liquid of nearly the same density as that for which the tank is intended. If this is not practical, water may be used and suitable corrections applied.
  - (ii) During liquid calibration any space under the roof that will trap gas should be vented to the atmosphere.



- (iii) Before liquid calibration the height of the lowest joint of the roof with reference to datum point should be recorded, wherever possible.
- (iv) To assess the point at which roof becomes oil borne the following procedure may be followed:

With the roof resulting fully on its supports, point four short horizontal white lines about 3 cm wide on the tank sides in such a position that, viewed from some definite point, their lower edges are just above four similar lines marked on the roof edges or shoes. Then slowly pump oil into the tank; when all roof markings are seen to have moved upwards, regard the roof as oil borne, and take the dip reading of the oil at this level.

Alternatively, from some chosen view point on the dipping platform, note the position of the roof against rivet heads on vertical seam or other markings on the tank walls instead of paint marks. In both cases extend the points of reference round the greater part of the tank interior, and see movement relative to all points.

(d) **Weight Floating:** The floating weight of the entire roof shall include weight of roof plus half the weight of the rolling ladder and other hinged and flexibility supported accessories that are carried up and down in the tank with the roof. These are calculated by the tank fabricator and given on the drawing and on the roof name-plate.

(e) **Deadwood**

- (i) Fixed deadwood shall be measured as described in 12. The drain lines and other accessories attached to the underside of the roof shall be treated as fixed deadwood in the position, they occupy when the roof is at rest on its supports.
- (ii) When all or part of the weight of the roof is resting on its supports, the roof itself is deadwood and as the liquid level rises around the roof its geometric shape will determine how it should be deducted. The geometric shape should be taken from the fabricator's drawings or measured in the field with the aid of an engineer's level while the roof is resting on its supports.



## 16. VARIABLE VOLUME ROOFS

- (a) Roofs such as lifter, flexible membrane, breather or balloon, may require special deadwood measurements for roof parts that are sometimes submerged. When these parts, such as columns, are fixed relative to the tank shell, they should be measured as deadwood in the usual way. When these parts move with the roof and hang down into the liquid, they should be deducted as fixed deadwood with the roof in the lowest position. Details may be secured from the fabricator or measured in the field.
- (b) Some variable volume roofs have flexible members which may float on the surface when the membrane is deflated and the liquid level is high. The floating weight of the membrane displaces a small volume of liquid. Data on the floating weight should be secured from the fabricator and supplemented, if necessary, by field observation and measurement.
- (c) Some variable volume roofs have liquid seal troughs or other appurtenances which makes the upper outside part of the shell inaccessible for outside circumference measurements. Liquid calibration of this portion of the shell may be made, or (i) theoretical dimensions may be taken from the fabricator's drawings, or (ii) the highest measurable circumferential measurement may be used as a basis for the portion of the tank that cannot be measured. When the method (i) or (ii) is used, it shall be so indicated on the calibration table.

## SECTION II—CALIBRATION BY INTERNAL MEASUREMENT

### 17. GENERAL

- (a) This method is based on the measurement of internal diameters.
- (b) Diameters shall be measured only after the tank has been fitted at least once at its present locations with the product to its working capacity or with water to its equivalent height, and such product or water has been held in the tank for at least 24 hours to allow for setting.
- (c) The stipulated number of internal diameters shall be obtained as described under 19 (a) (iv).
- (d) Where practicable, an external circumference shall be measured at approximately the same height as that at which a set of diameters of which a verification is desired, has been taken. The resulting internal diameters shall be compared, and if a discrepancy is found, the measurements shall be verified.



- (e) It may be necessary in practice to refer all tank dips to a datum point other than the datum point used for the purpose of tank calibration. If so, the difference in levels between these datum points shall be determined either by normal surveying methods or by other suitable means.
- (f) The overall height shall be measured using dip-tape and dip-weight, from the dipping datum point mentioned in (e) above to the reference point (the dipping reference point) on the dip hatch. This overall height shall be recorded and marked on the tank at the dip hatch.

## 18. EQUIPMENT

- (a) Steel Tape-complying with the specification given under Part III of the Fifth Schedule. The tape shall be greased well before use.
- (b) **Dynamometer:** This is used for applying tension to the steel tape.
- (c) Other equipment as referred to under 8.

## 19. DIAMETER MEASUREMENTS

### (a) Procedure

- (i) All diameter measurement shall be made with a tension of  $4.5 \pm 0.5$  kg applied to the tape as indicated by the dynamometer.
- (ii) All tape measurements shall be recorded as read, that is without including the length of the dynamometer.
- (iii) The dynamometer length at 4.5 kg shall be taken accurately before it is put into commission, and subsequently checked before and after calibration of each tank, the final check being made before leaving the site.
- (iv) The measurements shall be taken between diametrically opposite points at the following levels on each course (ring) the minimum number allowable at each level being two on each course (ring), at right angles to each other:

(iv) (a) for riveted tanks (see Fig.1)

- (1) at 10 per cent of the height of exposed portion of each course (ring) about the level of the top of the bottom angle iron of the tank and above the upper edge of each horizontal overlap between courses (rings); and



- (2) at 10 per cent of the height of exposed portion of each course (ring) below the level of the lower edge of each horizontal over-lap between courses (rings) and below the level of the lowest part of the top angle iron of the tank:
- (iv) (b) For welded tanks (see Fig. 2) = two levels, the upper and the lower levels, at the top and the bottom of course (ring), shall be 20 per cent of the height of the exposed portion of the respective course (ring) away from the angle irons or seams;
- (iv) (c) **All tanks:** No measurement shall be taken nearer than 30 cm to any vertical seam.
- (v) If for any reason it is impracticable to take measurements at the positions described above, then the diameters shall be taken as close to the proper position as practicable, but not nearer the horizontal seams than is specified under (d) above.
- (vi) The levels at which measurements have been taken shall be recorded together with reasons for abandoning the prescribed level.
- (vii) Measurements shall be taken with the zero end of the steel tape attached to the dynamometer, one operator placing the dynamometer on the predetermined point and the second operator placing the rule end-on to a point diametrically opposite. The tape with the graduated side wholly upwards is then pulled along the rule until the requisite tension is registered by the sounding of the buzzer in the dynamometer. The relative position of tape and rule is maintained by a firm grip until the rule is removed from the side of the tank and the measurement read on the tape at the end of the rule which was previously in contact with the tank side. The operation shall be repeated at the various positions at which measurements are required throughout the tank. The measurements shall be recorded clearly in white chalk on the steel plates in such a manner as to indicate the positions at which they were taken.
- (viii) Each measurement of diameter shall be recorded to the nearest.
- (b) All other measurements shall be followed in accordance with Section -1.



**PART-4****METHOD FOR COMPUTATION OF CAPACITY TABLES FOR  
VERTICAL OIL STORAGE TANKS****1. SCOPE**

This method prescribes the methods of computation on capacity tables for vertical storage tanks intended for bulk storage of petroleum and liquid petroleum products.

**2. GENERAL**

(a) The calculations shall be made in accordance with accepted mathematical principles.

(b) At the head of each capacity table it shall be clearly stated that the dip/capacity relationship applies only to dips taken at one specified point. This point shall be clearly marked on the tank, and the height of the dipping reference point shall be recorded at the head of the capacity table.

**3. FORM OF TANK TABLES**

Provided that tank tables have been prepared in accordance with the principles laid down in this standard the form in which the table is set out will not alter the accuracy of the figures obtained from it but the following principles shall be applied in preparing the tank tables:

(i) The intervals of dip at which the tables are set out shall not be so great that interpolation for intermediate dips is difficult. It is convenient to set out tables at intervals of dip not greater than 5 cm for then a small proportional parts table, calculated on the average content of tank per unit depth, may be used for calculating the litres corresponding to inter-decimal dips. In the case of lap joints, however, the proportional parts table should be set out for every course (ring). Levels affected by bottom irregularities and deadwood shall not be included in calculating the average capacity per unit depth used for the proportional parts table; and this table shall not be applied in interpolations at these levels.

(ii) The tables may be set out more fully; this may be justifiable in some cases where the greatest speed in calculation is desired, but it shall be remembered that a table set out on a single sheet of paper is often quicker in use than one which occupies several pages.



(iii) It should be remembered that, at best, no oil measurement can be relied upon to nearer than one part in 10,000. Commercial tables should never be set out to show any fractions of a litre, and minor discrepancies within this limit shall be disregarded.

(iv) In general, therefore, it is recommended that tables should be set out to show litres at intervals of 5 cm in dip with a proportional parts table for intermediate dips, the latter being set out against millimetres.

(v) A recommended format of a calibration chart for butt welded tanks is given in Table 2.

#### 4. STRAPPING METHOD

##### CORRECTIONS TO BE APPLIED TO MEASURED CIRCUMFERENCES

###### (a) Step-over

(i) For each obstruction the excess or deficiency of the tape measurement spanning the obstruction as compared with the step-over interval for the course (ring) concerned shall be subtracted from or added to the circumference figure obtained by strapping, and the result shall be taken as the corrected circumference, free from error due to the displacement of the tape from its proper path by the obstruction concerned.

(ii) Step-over correction shall be included for all vertical seams where it is detectable, in the case of vertical seams provided that the tape path used is entirely clear of rivet heads, an average step-over correction may be determined for each course (ring) and multiplied by the number of seams per course (ring) to obtain the total correction to be applied to the measured circumference of that course (ring) to compensate for such overlaps.

(iii) For single obstructions, only step-over corrections 2 mm or over shall be included.

(iv) The use of the step-over corrects circumferences for the effect on them of vertical seam overlaps but does not correct the tank tables for the effect as deadwood of internal projections of the seam edges. These shall be computed and accounted for as deadwood.

(v) By choosing tape courses in order to avoid appurtenances, use of step-overs could be eliminated to a great extent.



**(b) Plate Thickness**

Plate thickness measured shall be recorded to the nearest 0.1 mm.

**(c) Temperature Correction**

Where the strapping and dipping tapes are calibrated at 20°C, and the tank table is to be corrected for use with the shell at 15°C, from each measured circumference shall be subtracted 0.000 09 times the measured circumference, before the figure is taken into further calculation.

**5. CALCULATIONS**

(a) The mean external circumference of any course (ring) shall be the average of the circumferences measured on it and corrected to the nearest 0.1 mm.

(b) The mean internal circumference of the course (ring) shall then be calculated from the mean external circumference of the course (ring) by subtracting from the latter  $2\pi$  times the plate thickness in metres.

(c) The open capacity of each course (ring), that is, its capacity without allowing for deadwood shall be calculated as if the course (ring) were a true cylinder of the mean internal circumference determined as under (b) above. This rule shall apply to vertical cylinders of in and out, telescopic or shingled construction.

(d) The open capacity of each course (ring) in litres per centimetre of height shall be obtained by using either the following formula or any other mathematically equivalent process:

$$\text{Open capacity in litres per centimetre} = \frac{C^2 \times 10000}{4\pi \times 1000.023} \\ \text{or } 0.795752 \times C^2$$

where,

C = the mean internal circumference in metres.

(e) For tanks which are inclined to the vertical, these formulae shall be modified as given in Clause-11.

(f) Specimen calculations are given in clause-12.

## 6. INTERNAL MEASUREMENT METHOD

### CORRECTIONS TO BE APPLIED TO DIAMETER MEASUREMENTS

(a) Deductions shall be made from the average tape readings obtained in measuring diameters to allow for the effect of sag. The correction  $Z$  for sag expressed in metres is given by the formula:

$$Z = \frac{W^2 S^2}{24P^2} K S^2$$

where,

$P$  = pull on tape in kg,

$S$  = span of tape *i.e.* outside circumference of the tank in m,

$W$  = weight of tape in kg/m, and

$$K = W^2 = \frac{\text{constant}}{24P^2}$$

#### Example:

For a tape 10mm wide and 0.25 mm thick, made of steel of density 7850 kg,  $m^3$ , values of  $K$  to give the correction in centimeters when the tape is stretched with flat side horizontal, will be

P	K
4.4kg	$8.29 \cdot 10^{-5}$
4.5kg	$7.92 \cdot 10^{-5}$
4.6kg	$7.58 \cdot 10^{-5}$

The above formula gives practically the same results as the equation of the catenary and is less cumbersome.

(b) To the average diameter of each course (ring), corrected for sag, add the length of the dynamometer when registering a pull of 4.5kg.

(c) Corrections for the effect of stretch are unnecessary because the tension applied is that at which the tape is standardized.

(d) Corrections for temperature shall be made as specified in 7 (c).



## 7. CALCULATIONS

(a) The mean diameter measurement will consist of the average, of the separate tape readings corrected for sag, plus the length of the dynamometer.

(b) The procedure shall, therefore, be:

(i) Average the tape readings obtained for each course (ring), by dividing the sum of all these readings on the course (ring) by their number. Round off this average to the nearest 0.1mm.

(ii) Correct the mean result of (i) for sag as specified in 6 (a).

(iii) Add to the result of (ii) the dynamometer length as specified in 6 clause (b).

(c) Where the measuring and dipping tapes are calibrated at 20°C, and the tank table is to be correct for use with the shell at 15°C, multiply the result obtained in b (iii) above by (1-0.00009), before the figure is taken into further calculation. Round off this figure to the nearest 0.1 mm. (d) Calculate the open capacity of each course (ring) that is its capacity without allowing for deadwood, as if the course (ring) were a true cylinder of the mean internal diameter determined under (b) above. This rule shall apply to vertical cylinders of in-and-out telescopic or shingled construction.

(e) The open capacity of each course (ring) in litres per centimetre of height shall be obtained by using the following formula or by any other mathematically equivalent process:

$$\frac{D^2 \times \pi}{1000.028 \times 4} = \text{or } 0.000785376 \times D^2$$

where,

D = the mean internal diameter in centimetres.

(f) For tanks which are inclined to the vertical, modify these formulae as given in II.

(g) When the level or levels from which oil depths will be measured differ from the datum level from which the tank table is first prepared, correction for difference shall be made in the final table.

(h) Specimen calculations are given in clause-13.

## 8. DEADWOOD

(a) The open capacity of each course (ring) shall be adjusted for any deadwood it contains.

(b) The total volume of each piece of deadwood shall be calculated to the nearest litre. In this context, the term 'piece of deadwood' shall include such items as the rivet heads in one line around the tank, taken collectively, as a single 'piece' of deadwood.

(c) The effect of small pieces of deadwood may be neglected provided that (i) the total effect of any such neglect shall not lead to error in the tank tables exceeding 0.005 per cent of the total capacity of the course (ring) in which the deadwood occurs, and (ii) any deadwood so neglected is distributed evenly, or substantially so, over the whole height of the course (ring), in calculating the table, however, it shall be permissible to include the effect of any deadwood, however small.

## 9. TANK BOTTOMS

(a) When the tank bottom is substantially horizontal, for example, when the tank is carried on a level concrete raft or steel structure, then bottom irregularities can be neglected.

(b) When the tank bottom has been calibrated by measuring in suitable known volumes of liquid, the tank table for these levels shall be prepared from these measurements on sound mathematical principles. The highest level and capacity shown in the tank bottom calibration table so prepared shall then be the datum level and capacity from which is to be constructed the rest of the table should be prepared by calculation as described in this section.



## 10. FLOATING ROOF TANK

(a) Except for the following modifications, tables shall be prepared in accordance with section I and section II.

(i) Allowance for deadwood shall be made as described in Clause 8.

(ii) The drain line and other accessories attached to the underside of the roof shall be included as fixed deadwood in the position they occupy when the roof is at rest on its supports. The position of these accessories should be specified in the calibration table.

(iii) Two levels shall be defined, both an exact number of centimetre above the datum point from which dip readings will be taken. The first level, designated A, shall be not less than 4 cm and not more than 6 cm below the lowest point of the roof plates when the roof is at rest. The second level, designated B, shall be not less than 4 cm and not more than 6 cm above the free oil surface when the roof is at its lowest oil borne position.

(iv) The floating weight of the entire roof shall include weight of roof plus half the weight of the rolling ladder and other hinged and flexibly supported accessories that are carried up and down in the tank with the roof.

The displaced volume due to roof weight can be easily calculated from:

roof weight in KG

Density of the stock in kg/litre at tank temperature.

This displacement, minus the volume of deadwood already accounted for in (ii) above, shall be considered as an item of deadwood applicable to all levels above B. It shall either be entered as such on a supplementary table or taken into account in the preparation of the final table as a deduction for deadwood at all levels above B. For levels between A and B, the proportion of roof displacement to be taken into account as deadwood may be calculated

from the dimensions of the floating roof. These partial displacements shall either be entered as such in the supplementary table as applicable for levels between A and B, or taken into account in preparation of final table. Alternatively where measured quantities of oil have been admitted to the tank and corresponding levels of the free oil surface determined by dipping, the necessary adjustments to the tank capacity within the range of the level A and B may be computed from this data. The part of the table between level A and level B shall be marked 'not accurate'.

(v) It is considered impracticable to allow in the tank table, for the effects of extraneous matter retained by the roof, varying friction of the roof shoes and varying immersion of roof supports.

#### 11. COMPUTATION OF CONTENTS OF TANKS INCLINED TO THE VERTICAL

[See Clauses 5 (e) and 7 (f)]

##### (a) TANKS INCLINED TO THE VERTICAL

(i) Capacity as determined in 5 (e) and 7 (e) applies to tanks which are vertical. For tanks inclined to the vertical at an angle  $\theta$ , the open capacity in litres per centimetres of vertical height, is given by:—

$$0.795752 \times C^2 \times \sec \theta$$

where C = the mean internal circumference in metres.

$$\text{OR, } 0.000\ 785\ 376 \times D^2 \sec \theta$$

where D = the mean internal diameter in centimetres.

Sec  $\theta$  may be ignored for angles of tilt up to 1 in 50, this representing a maximum error of 0.02 per cent.

(ii) The correction specified above shall be applied before the corrections for deadwood are made.

[See Clause 5 (f)]



## 12. EXAMPLE FOR STRAPPING METHOD

## (a) Data Obtained by Strapping

Course (Ring) No.	Measured External Circumference metres	Step-Over Corrections	Plate Thickness mm	Internal Heights of Courses (Rings)	
				Individual 1cm	Cumulative cm
8 Top	113.040	0.002	7	187.0	1475.0
8 Middle	113.085	0.002	7		
8 Bottom	113.086	0.002	7		
7 Top	113.127	0.002	7	179.0	1288.0
7 Middle	113.133	0.002	7		
7 Bottom	113.130	0.002	7		
6 Top	113.090	0.003	10	190.0	1109.0
6 Middle	113.096	0.003	10		
6 Bottom	113.092	0.003	10		
5 Top	113.152	0.004	13	179.0	919.0
5 Middle	113.160	0.004	13		
5 Bottom	113.155	0.004	13		
4 Top	113.085	0.010	13	191.0	740.0
4 Middle	113.092	0.010	13		
4 Bottom	113.090	0.010	13		
3 Top	113.175	0.010	16	178.0	549.0
3 Middle	113.176	0.010	16		
3 Bottom	113.170	0.010	16		
2 Top	113.077	0.013	18	191.0	0317.0
2 Middle	113.081	0.013	18		
2 Bottom	113.075	0.013	18		
1 Top	113.187	0.015	20	180.0	180.0
1 Middle	113.089	0.015	20		
1 Bottom	113.175	0.015	20		

**(b) Additional Data**

**(i) Deadwood**

Course (Ring) No.	Applicable Height cm	Deadwood	Total Deadwood Courses Litres	
			litres	l/cm
8	1466 to 1475	-350	-38.889	
8	1415-1466	-508	9.961	
8	1350-1415	2336	-35.938	
8	1288-1350	nil	nil	-3 194
7	1109-1288	nil	nil	
6	919-109	nil	nil	
5	740-919	nil	nil	
4	549-740	0195	-1.021	* 195
3	371-549	-259	-1.455	-259
2	180-371	-309	-1.618	-309
1	107-180	-145	-1.986	
1	51-107	-59	-1.054	
1	46-51	-36	-7.200	
1	0-46	nil	nil	-122

(ii) Tape calibration temperature  $-20^{\circ}\text{C}$

(iii) Condition of tank at time of strapping :

Water in tank of depth of 1400 cm  
 Water temperature  $20^{\circ}\text{C}$   
 Density of water at  $-20^{\circ}\text{C}$  1,000 kg/l

**(c) Calculation of Corrected Internal Circumferences**

**Course (Ring) No. 8 Top**

Measured external circumference at  $20^{\circ}\text{C}$  113-040 0 m  
 Correction for calibration temperature of tape -C-0010 2 m  
 Calculated external circumference at  $15^{\circ}\text{C}$  113-029 8 m  
 Step-over correction -0-002 0 m  
 Correction for plate thickness  $7 \times 2_n = 7 \times 6.2832 \text{ mm}$   
 -0-0440 m  
 Corrected internal circumference 112-983 8 m

(Calculation for other courses may be done in a similar way)

The corrected internal circumferences for the remaining measurements given above are shown below.



## (d) Calculation of Open Capacity of Courses (Ring)

Course (Ring) No.	Corrected Internal Circumference metres	Mean Internal Circumference	Open Capacity of Courses (Ring)	
			1/cm	litres
1	2	3	4	5
8 Top	112-983 8	113-014	10 163-48	1 900 571
8 Middle	113-029 8			
8 Bottom	113-029 8			
7 Top	112-070 8	113-073	10 174-22	1 821 185
7 Middle	113-076 8			
7 Bottom	113-073 8			
6 Top	113-014 0	113-016 4	10 163-95	1 931 150
6 Middle	113-020 0			
6 Bottom	113-016 0			
5 Top	112-056 1	113-059 8	10 171-70	1 820 734
5 Middle	113-064 1			
5 Bottom	113-059 1			
4Top	112-983 1	112-987 1	10 158-62	1 940 296
4 Middle	112-990 1			
4 Bottom	112-988 1			
3 Top	113-054 3	113-053 0	10 170-48	1 810 345
3 Middle	113-005 3			
3 Bottom	113-039 3			
2 Top	112-940 7	112-941 4	10 150-41	1 938 428
2 Middle	112-944 7			
2 Bottom	112-938 7			
1 Top	113-036 1	113-032 8	10 166-84	1 830 031
1 Middle	113-038 1			
1 Bottom	113-024 1			

Total : 14 993 040

(e) Calculation of Net Capacity or Course (Ring)

Oil Dip	Open Capacity	Dead Wood	Net Capacity
Cm	l/cm	l/cm	l/cm
1	2	3	4
0 to 46	10 166.84	nil	10 166.84
46 to 51	10 166.84	-7.304	10 159.6
50 to 107	10 166.84	+1.05	10 167.89
107 to 180	10 166.84	-1.99	10 164.85
180 to 371	10 150.41	-1.62	10 148.79
371 to 549	10 170.48	-1.46	10 169.02
549 to 740	10 158.62	-1.02	10 159.60
740 to 919	10 171.70	nil	10 171.70
919 to 1 109	10 163.95	nil	10 163.95
1 109 to 1 1288	10 174.22	nil	10 174.22
1 288 to 1 350	10 163.48	nil	10 163.48
1 350 to 1 415	10 163.48	-35.94	10 127.54
1 415 to 1 466	10 163.48	-9.96	10 153.52
1 466 to 1 475	10 163.48	-38.89	10 129.54

13. EXAMPLE FOR INTERNAL MEASUREMENT METHOD

[See Clause 7(h)]

(a) Data Obtained by Internal Measurement

In this example it is assumed that the same tank as in 12 has been calibrated by internal measurement. The means of each course (ring) of the tape measurements of the internal diameters are as in col. 2 of the table in (d) below.

Dynamometer length at a tension of 4.5kg = 21.30 cm

(b) Additional Data

All course (ring) height deadwood, etc are the same as in 12.

(c) Sag Correction

For a tension of 4.5kg, the sag correction to course (ring)

No. 1 is :

$$7.89 \times 10^{-5}(35.7878)^3 = 3.61 \text{ cm.}$$



(d) Calculation of Correct Internal Diameter  
Course (Ring) No. 1

Mean tape reading for diameter	3 578.78 cm
Sag correction (deduct)	3.61 cm
Corrected tape reading	3 575.17 cm
Dynamometer length (add)	21.30 cm
Measured internal diameter at 20°C	3 596.47 cm
Correction for calibration temperature of tape (deduct)	0.32 cm
Corrected internal diameter at 15°C	3 596.15 cm

The corresponding tape reading and corrected internal diameters calculated as shown above, for all course (rings) are tabulated below :

Course (ring) No.	Mean Tape Reading	Mean Tape Reading for Diameter Corrected for Sag and Dynamometer	Mean Internal Diameter Corrected for Tape Calibration Temperature
	cm	cm	cm
8	3 579.75	3 597.12	3 597.44
7	3 580.92	3 598.29	3 598.61
6	3 578.90	3 596.27	3 596.59
5	3 580.12	3 597.49	3 597.81
4	3 577.50	3 594.88	3 595.20
3	3 579.47	3 596.84	3 597.26
2	3 576.95	3 593.33	3 593.65
1	578.78	3 596.15	3 596.47

## (e) Calculation of Open Capacity of Courses (Rings)

Course (Ring) No.	Open Capacity of Course (Ring) l/cm	Open Capacity of Course (Ring) litres
8	10 162.17	1 900 326
7	10 168.79	1 820 213
6	10 157.37	1 929 900
5	10 164.27	1 819 404
4	10 149.52	1 938 558
3	10 160.59	1 808 585
2	10 140.77	1 938 887
1	10 156.99	1 828 204
		Total : 14 982 077

## (f) Calculation of Net Capacity of Course (Ring)

Oil Dip cm	Open Capacity l/cm	Deadwood l/cm	Net Capacity l/cm
0 to 46	10 156.69	nil	10 156.69
46 " 51	10 156.69	-7.20	10 149.49
51 " 107	10 156.69	+1.05	10 157.74
107 " 180	10 156.69	-1.99	10 154.70
180 " 371	10 140.77	-1.62	10 139.15
371 " 549	10 160.59	-1.46	10 159.13
549 " 740	10 149.52	-1.02	10 148.50
740 " 919	10 164.27	nil	10 164.27
919 " 1 109	10 157.37	nil	10 157.37
1 109 " 1 288	10 168.79	nil	10 168.79
1 288 " 1 350	10 162.17	nil	10 162.17
1 350 " 1 415	10 162.17	-35.94	10 126.23
1 415 " 1 466	10 162.17	-9.96	10 152.21
1 466 " 1 475	10 162.17	-38.89	10 123.28



[See Clause 3(a)/(v)]

**Table 2—RECOMMENDED FORMAT OF A CALIBRATION CHART FOR BUTT WELDED TANKS**

Proportional parts		Tank No.....						
		Code .....						
		Type .....						
		Diameter or .....						
		Circumference .....						
		Height .....						
Litres	cm Litres	cm Litres	cm Litres	cm Litres	cm Litres	cm Litres	cm Litres	cm Litres
1	2	3	4	5	6	7	8	9
1	00	200	400	600	800	1000	1200	1400
2	05	05	05	05	05	05	05	05
3	10	10	10	10	10	10	10	10
4	15	15	15	15	15	15	15	15
5	20	20	20	20	20	20	20	20
6	25	25	25	25	25	25	25	25
7	30	30	30	30	30	30	30	30
8	35	35	35	35	35	35	35	35
9	40	40	40	40	40	40	40	40
10	45	45	45	45	45	45	45	45
11	50	50	50	50	50	50	50	50
12	55	55	55	55	55	55	55	55
13	60	60	60	60	60	60	60	60
14	65	65	65	65	65	65	65	65
15	70	70	70	70	70	70	70	70
16	75	75	75	75	75	75	75	75
17	80	80	80	80	80	80	80	80
18	85	85	85	85	85	85	85	85
19	90	90	90	90	90	90	90	90
20	95	95	95	95	95	95	95	95
21	100	300	500	700	900	1100	1300	1500

1	2	3	4	5	6	7	8	9
22	105	05	05	05	05	05	05	05
23	10	10	10	10	10	10	10	10
24	15	15	15	15	15	15	15	15
25	20	20	20	20	20	20	20	20
26	25	25	25	25	25	25	25	25
27	30	30	30	30	30	30	30	30
28	35	35	35	35	35	35	35	35
29	40	40	40	40	40	40	40	40
30	45	45	45	45	45	45	45	45
31	150	350	550	750	750	950	1150	1350
32	55	55	55	55	55	55	55	55
33	60	60	60	60	60	60	60	60
34	65	65	65	65	65	65	65	65
35	70	70	70	70	70	70	70	70
36	75	75	75	75	75	75	75	75
37	80	80	80	80	80	80	80	80
38	85	85	85	85	85	85	85	85
39	90	90	90	90	90	90	90	90
40	95	95	95	95	95	95	95	95
41								
42								
43								
44								
45								
46								
47								
48								

**Data regarding strapping, dimensions, etc.**

Approved by

Signature

Date



**Schedule XXIII***(See rule-13)***SPECIFICATION FOR MEASURING INSTRUMENT***(See Rule 13)*

- (a) A measuring instrument shall be of such material, design and construction as to ensure, under normal working conditions, the following requirements :
- (i) accuracy is maintained;
  - (ii) operating parts continue functioning satisfactorily, and
  - (iii) adjustment remains reasonably permanent.
- (b) A measuring instrument shall not be stamped unless it is complete with all parts and attachment concerned with the operation of measurement and delivery.
- (c) Where an instrument has interchangeable or reversible parts, their interchangeability or reversal shall not affect the accuracy of instrument.
- (d) Every measuring instrument of fixed type shall be so installed that the viewer can readily obtain a clear and unobstructed view of the indication of measurement and delivery.
- (e) The design and construction of measuring instrument shall be such as would prevent, as far as possible tampering with the accuracy of the instrument either by inadvertent use or otherwise.

**PART-I****BULK METERS****1. GENERAL**

- (a) This part deals with the accuracy requirements for bulk meters used in petroleum trade.
- (b) Bulk meters shall not have a capacity below 100 litres.

**2. DEFINITIONS**

- (a) **Pressure Drop**—The difference between the inlet and outlet pressures of the meter and the pressure required to force liquid through the meter and overcome its resistance to movement.
- (b) **Hydraulic Slip or Slippage**—That quantity of liquid which passes through the meter without causing any registration.
- (c) **For Range**—That portion of the meter's total flow capacity in which it operates to meet the required degree of accuracy in measurement.



### 3. TYPES AND CONSTRUCTION

(a) Bulk meters used for measuring liquid petroleum products shall be positive displacement meters in which the liquid under a positive pressure head causes the measuring elements in the meter to rotate, reciprocate or otherwise move through and defined volumetric displacement before the liquid passes from the meter. This movement is interpreted through a train of gears on a register as a measure of liquid volume.

(b) Meters differ widely in construction, but in general they may be divided into the following two main classes :

(i) **Capillary Seal Meter**—Capillary seal means which may either be of reciprocating rotary or other types are sealed with a thin film of the liquid being measured and are usually characterized by a relatively low pressure-drop.

(ii) **'Packed or Mechanical Seal Meter'**—'Packed or mechanical seal meters' which are always of the reciprocating piston type are sealed by a suitably designed piston ring or washer to prevent 'slip' or leakage. They have a higher pressure-drop than capillary seal meters.

(c) Capillary seal meters are generally preferably for installation where gravity discharge is essential. Both 'packed' and capillary seal meters are suitable for pressure discharge.

(d) Meters are usually constructed of aluminium, aluminium alloys, bronze, brass or gun metal and stainless steel or special steels for certain small components. Carbon bearings and carbon vanes are also used since they operate satisfactorily without lubrication.

(e) Meters are sometimes fitted with automatically or manually operated temperature compensating devices. These devices correct the expansion or contraction of the liquid being measured with change of temperature and directly indicate the volume which the liquid would occupy at a standard temperature. The devices are satisfactory when the liquid temperature remains substantially constant; but when marked fluctuations in temperature occur, they should be used for accurate measurement only when their response to temperature changes is very rapid.

### 4. METER INSTALLATION

The installation of the bulk meter has a direct bearing upon its operation and such characteristics as the rate of flow and accuracy may be seriously affected if it is not correctly installed. It is, therefore, essential that where possible the layout be based on the followings :

(i) Meters shall be protected by a strainer or filter and an air eliminator fitted as close to the inlet as possible so as to remove all particles which are injurious to the meter and which might impair its accuracy. They shall not be at a lower level.



(ii) The pipework shall be so arranged that the strainer, air separator and meter cannot be accidentally drained.

(iii) All pipework and fittings shall be cleaned and flushed out to remove scale and foreign matter before installing the meter.

(iv) The meter shall be mounted securely on a horizontal base using rubber mounting pads to reduce shock and vibration where these are likely to occur.

(v) Inlet and outlet pipework shall not exercise strain on the meter body. Acute bends, toes and elbows shall be avoided as far as possible.

(vi) The layout shall be so designed as to facilitate removal of the meter without unnecessarily disturbing the pipework and sufficient space shall be provided to allow for meter calibration, cleaning and small servicing requirements.

(vii) If pipe jointing compounds are used, these shall be applied to the male parts not to female. It is vital not to allow any compound to enter the meter.

(viii) The meter shall be located so that the register is clearly readable by the operator from the control point.

(ix) Flow control valves, when fitted, shall be installed adjacent to the outlet of the meter. If a valve is installed on the inlet side, it shall be located at a sufficient distance on the upstream side to ensure a uniform steady flow through the meter when the valve is throttled.

(x) Pulsating flow, such as that caused by piston pumps, shall be avoided, if this is not possible to achieve a surge tank or alleviator should be installed upstream of the meter(s).

(xi) Meters shall not be installed on the sanction side of pumps.

## 5. TESTS

(a) All meters shall be tested under conditions, which duplicate normal operating conditions as closely as possible particularly in respect of rates of flow and the product involved.

(b) Before commencing checking of a meter, the meter shall be run for several minutes to ensure that all units are functioning smoothly.

(c) For testing of meters, a proving tank shall be used. The capacity of the proving tank shall be sufficient in size to contain at least one Minute's flow through the meter at its normal operating rate when used for bulk loading. The proving tank shall be tested against the working standard capacity measure of appropriate capacity.



(d) The procedure for testing shall be as follows :

(i) After all connections have been made fill the proving tank once with the full quantity in order to wet all surfaces, to fill the discharge hose and to ascertain that there are no leaks in the connection;

(ii) Empty the proving tank and close the outlet valve after it is completely drained;

(iii) Set the meter dial to zero reading;

(iv) Fill the proving tank through the meter to a point where the meter dial records the capacity of the proving tank. If the meter is fitted with an automatic presetting device, set this to deliver the capacity of the proving tank;

(v) Note the reading on the graduated gauge glass of the proving tank, which would show that the meter is :

within or beyond the maximum permissible error,

(vi) If it is beyond the maximum permissible error, adjust the meter until the errors are brought within the permissible limits;

(vii) Repeat steps (ii), (iii), (iv) and (v) until the meter gives two consecutive deliveries within the maximum permissible error;

(viii) If the meter has been found to give accurate measure in the initial test itself, make at least one more test to check the accuracy recorded.

## 6. MAXIMUM PERMISSIBLE ERROR

(a) The errors shall not (a) exceed = 0.1 per cent for any quantity discharged.

(b) The bulk meter shall be complete with all parts and attachments concerned with the operation of measurement and delivery.

## 7. MARKING

(a) Every bulk meter shall be conspicuously, clearly and prominently marked with the following indications :

(i) registering capacity;

(ii) name or registered trade mark of the manufacturer;

(iii) identification number.

(b) The bulk meter shall be provided with a plate fastened in a prominent place to receive the markings mentioned in (a) above and to receive the stamp of the Inspector's seal.

## 8. SEALING

Every bulk meter shall be provided with a suitable sealing arrangement to receive the stamp or seal of the verification authority.



## PART-2

## WATER METERS (DOMESTIC TYPE)

## 1. GENERAL

This part applies to inferential (horizontal-flow) and semi positive type of water meters with threaded end connections and of nominal sizes up to and including 50 mm. The part applies to both wet dial and dry dial meters.

## 2. TERMINOLOGY

(a) **Meter Casing**—The outer casing in which the entire meter mechanism is housed. It consists of the body the registration box, the cap and the lid. Some of these parts may be integral.

(b) **Body**—The part of the meter casing which houses the impeller chamber and the transmission gear train of the inferential water meter or the measuring chamber of the semi positive water meter.

(c) **Registration Box**—The part of the meter casing which houses the registration device.

(d) **Cap**—The part of the meter casing to which is fitted the dial cover and the lid.

(e) **Lid**—The cover which is hinged to the cap with a view to protecting the transparent dial cover.

(f) **Impeller chamber**—The enclosure in which the impeller of an inferential water meter operates. A separate impeller chamber may not be necessary in case where the body is designed to act as impeller chamber. The transmission gear train may be located either inside or outside the impeller chamber.

(g) **Measuring Chamber**—The enclosure in which the piston of a semi positive water meter operates. The transmission gear train may be located either inside or outside the measuring chamber.

(h) **Registration Device**—The unit which comprises the recording gear train and indicating device consisting of a counter or pointers working on a dial or a combination of both. It registers in suitable volumetric units the quantity of water which has passed through the meter.

(i) **Water meter—Dry Dial**—Meter in which the counter mechanism is isolated from water flowing through the meter.

(j) **Water Meter—Wet-Dial Type**—Meter in which the complete counter unit is in contact with water flowing through the meter.

(k) **Water Meter Inferential Type**—Meter which measures the velocity of flow from which the discharge is measure.

(l) **Water Meter Semi positive Type**—Meter which volumetrically records practically down to zero flow of the water that has passed through, with a small unavoidable leakage.



### 3. NOMINAL SIZES

Water meters shall be of the following nominal sizes; 15mm, 20 mm, 25 mm, 40 mm and 50 mm. The nominal size of the water meter shall be denominated by the nominal bore of its inlet.

### 4. MATERIALS AND MANUFACTURE

(a) **General**—Water meters and their parts, especially parts coming in continuous contact with water shall be made of materials resistant to corrosion and shall be non-toxic and non-tainting. Use of dissimilar metals in contact under water shall be avoided as far as possible in order to minimize electrolytic corrosion.

#### (b) Body

- (i) The body of water meters shall be made either from Type A or Type B materials as specified below :

**Type A**—The body of water meters shall be made from ferrous metal or suitable plastics.

**Type B**—The body of water meters shall be made from bronze, brass or any other corrosion-resistant material but not aluminium alloy.

- (ii) The body shall be free from all manufacturing and processing defects, such as blow-holes and spongy structure, and shall not be repaired by plugging, welding or by addition of materials. The internal shape of the body shall ensure smooth flow of water and easy dismantling.

(c) **Registration Box**—Registration box of water meters of Type A shall be made from bronze, brass, aluminium alloy or suitable plastics. Registration box of water meters of Type B shall be made from any of ferrous metals as specified for body of Type B meter, suitable plastics or aluminium alloys. The registration box of dry-dial water meters shall be provided with one or two escape holes for minimizing the accumulation of condensed water.

NOTE—Aluminium alloy shall not be used for wet-dial meters.

(d) **Cap**—Cap of water meters of Type A shall be made from brass, bronze aluminium alloy or suitable plastics. The cap of water meters of Type B shall be made of plastics or aluminium alloy; where the cap and registration box are integral, the material for cap may be the same as used for registration box. The cap shall be so designed and fixed to the registration box as to avoid entry of water and dirt. The transparent window which covers the dial shall be inserted from the inside into the cap. The protective lid shall be secured by a robust hinge or other suitable method of construction. Provision shall also



be made to lock the lid. The provision shall be such that the lock may be conveniently operated from the top. Where the provision is designed for use in conjunction with padlock, the hole provided for padlocks shall be of a diameter not less than 5 mm.

In dry-type water meters, the transparent window covering the dial may be provided with a wiper on the inner side for wiping off condensed water.

**(e) Connection**—The meter casing shall be fitted in the pipe line by means of two conical or cylindrical nipples or tail pieces with connecting nuts which shall be provided with each meter. The nipples of water meters of Type A shall be made of the same materials as specified for body [ in (b) above]. Nipples of water meters of Type B shall be made of the same materials as specified for body where they are integral with the body of the water meters where they are separate, they shall be made of malleable iron, galvanized steel or suitable plastics. The nut shall be of the same material as used for nipples. The internal diameter of the nipple where it connects the pipe line shall be equal to that corresponding to the nominal size of the meter.

**(f) Screws and studs**—Screws and studs shall be of brass or other corrosion resistant material.

**(g) Strainers**—Water meters shall be provided with strainers. Strainers shall be of a material which is not susceptible to electrolytic corrosion. They shall be of plastics or other corrosion resistant materials for both Type A and Type B meters. They shall be rigid easy to remove and clean and shall be fitted on the inlet side of the water meter. It shall be possible to remove and clean the strainer in such a way as not to permit disturbing the registration box or tampering with it. The strainer shall have a total area of holes not less than twice the area of the nominal inlet bore of the pipe to which the meter is connected however in the case of meters provided with internal strainer, involving opening of the registration box for cleaning an additional external strainer shall be fitted on the inlet side satisfying the above requirements.

**(h) Impellers and Pistons**—(i) Impellers of inferential meters shall be of ebonite, vulcanite or suitable plastic or other non-absorbent material or it shall be of corrosion resistant metal. It shall be accurately balanced. Impeller shall rest on a self-cleaning hearing which has a low frictional resistance as possible and shall be non-absorbent and corrosion-resistant material.

(ii) Impeller shall may also be made of suitable plastics having adequate strength and wear-resisting properties.

(iii) Rotary or oscillating pistons in the case of semi positive type meters shall be of non absorbent material, such as vulcanite or ebonite. Pistons shall be accurately finished and shall operate freely.

(iv) Impellers and pistons shall be durable and shall work with as a low a frictional resistance as possible.



(i) **Impeller or Measuring Chamber**—The impeller or measuring chamber shall be of a corrosion resistant material and shall be rigid and shall not change its forms as a result of internal stresses or with use.

(j) **Gears and Pinions**—Gears and pinions shall be so constructed as to fully and smoothly mesh with each other and shall be firmly fitted on their shafts. Gears and pinions coming in contact with water shall conform to the material specified for impeller shaft in h(i) and h(ii) above.

(k) **Bearings**—Impeller bearings shall be of a gate, sapphire or any other suitable material with good wear resisting properties, suitably ground and polished. The shape of the impeller bearing shall be such as to prevent the penetration of particles of sand and to preclude the deposit of any thing in solution or suspension in water and to facilitate the washing way of such deposits by the water flow. The shafts of the gears shall revolve freely in their bearings. The length of the bearings shall ensure their effective operation.

(l) **Counter**—The counter shall be made of the material which will not corrode or distort, such as plate brass or suitable plastics. The counter shall be of the circular multipointer pattern with all pointers reading clockwise. The individual pointers shall be located on the dial so that the reading can be taken in a clockwise direction. The indicating device may also be of the straight reading counter or a combination of pointer and counter. The rollers of the counters shall be made of nickel or nickel-plated and brass or plastics specially suitable for the purpose and shall be self-lubricating.

The ranges of registration shall be as given in Table 3.

TABLE 3

RANGES OF REGISTRATION OF WATER METERS

Nominal size of water meter	Minimum registration per dial division	Maximum registration
1	2	3
mm	litres	litres
15	1	10,000,000
20	1	1,000,000
25	1	10,000,000
40	10	100,000,000
50	10	100,000,000

(m) **Dial**—The dial shall be of vitreous enamel on copper, anodized aluminium or plastics or of any other suitable material ensuring indestructible marking and good legibility. The unit of measurement, namely 'litre' shall be marked on the dial as 'LITRES' in bold face.



(n) **Sealing**—Sealing holes shall be provided and the metres shall be sealed in such a manner as to render it impossible to obtain access to the measuring unit without breaking the seals. The sealing wire shall be rustproof.

(o) **Regulator**—Every inferential meter shall be provided with a register. The regulator shall be either accessible from outside to be worked by a key without dismantling the meter and protected by a seal cover or the regulating device shall be internal and not accessible from outside.

(p) **Location of Serial Number**—The serial number of the meter shall be clearly indicated on the screw cap or in any other suitable place.

## 5. OVERALL DIMENSIONS

Overall dimensions of the water meters shall be as specified in Table 4.

TABLE 4  
OVERALL DIMENSIONS OF WATER METERS

Nominal size of meter	(All dimensions in millimeters)		
	Overall length includes nipples	Overall width Max	Overall height Max
15	250	130	180
20	290	130	180
25	380	140	200
40	430	230	250
50	470	250	300

Tolerance on the overall length shall be  $\pm 5\text{mm}$

## 6. PERFORMANCE REQUIREMENTS

(a) **Temperature**—The meters shall be suitable for use with water temperature up to  $45^{\circ}\text{C}$ .

(b) **Hydrostatic Test**—Meters shall satisfactorily withstand a pressure of 200 kpa.

(c) **Capacity on short Period Rating or Nominal Capacity**—The nominal capacity of the water meters shall be as specified in Table 5. The meters shall be capable of giving minimum discharges as stated in the table without the head-loss exceeding 10 m within the meter.

(i) **Head**—Loss within the meters shall be measured in accordance with the method given in Appendix 'A'.



TABLE 5

Nominal capacity of Water Meters

Nominal size of meter	Discharge per hour	
	Semi positive Type	Inferential Type
mm	litres	lites
15	2,000	2,500
20	3,400	4,500
25	5,500	7,500
40	10,000	16,000
50	15,000	23,000

(d) **Continuous Running Capacity**—Continuous running capacity of water meters shall be as specified in Table 6. The meters shall be capable of giving the minimum discharges as stated in the table without the head-loss exceeding 3 m within the meter.

Continuous running capacity of water metres.

TABLE 6

Nominal size of meter	Discharge per hour	
	Semi positive Type	Inferential Type
mm	litres	lites
15	1,000	1,500
20	2,000	2,500
25	3,000	3,500
40	6,000	8,000
50	9,000	14,000

(i) **Head**—Loss within the meter shall be measured in accordance with the method given in Appendix 'A'.

(e) **Minimum Starting Flows**—The minimum flow at which the meter starts registering shall be as given in Table 7.

TABLE 7

Minimum Starting Flow

Nominal size of meter	Minimum starting flow per hour	
	Semi positive Type	Inferential Type
mm	litres	litres
15	10	40
20	15	60
25	20	75
40	25	100
50	30	175

(f) **Metering Accuracy**

(i) The metering accuracy shall be  $\pm 2$  per cent for both semi-positive and inferential water meters above the lower limit of flow specified in (ii) below.

(ii) Lower Limit of flow for  $\pm 2$  per cent Metering Accuracy.

The lower limit of flow at which the meter will start registering at an accuracy of  $\pm 2$  per cent shall not be more than  $1/20^{\text{th}}$  and  $1/40^{\text{th}}$  of the nominal capacity in the case of inferential and semi positive water meters, respectively.



## 7. FROST PROTECTION DEVICES

Meters liable to be damaged by frost shall be protected with suitable frost protection devices.

## 8. TESTS

The following tests shall be conducted on each and every water meter before fixing the seal of the verification authority:

### (a) Hydrostatic test :

The meter shall satisfactorily withstand a pressure of 2,000 kpa.

### (b) Nominal capacity test :

The nominal capacity of the water meter, measured by the quantity of water which shall pass without the head loss, within the meter, exceeding ten meters, shall be specified in Table 5. This test shall be conducted for about 1 minute.

### (c) Continuous running capacity test :

The continuous running capacity of the water meter, measured by the quantity of water which the meter shall pass, without the head loss, within the meter, exceeding three meters, shall be as specified in Table 7. This test shall be conducted for about 2 minutes.

### (d) Minimum starting flow test :

The meter shall be tested for the minimum flow on which it starts registering and shall conform to the requirements specified in Table 7. The test shall be conducted for about 5 minutes.

(e) **Metering accuracy test :** The meter shall be tested for its metering accuracy and shall conform to the requirements of the paragraph 6(f).

## 9. MARKING

(a) Each water meter shall be marked with the following informations :

- (i) manufacturer's name or trade mark,
- (ii) nominal size of the meter, and
- (iii) direction of flow of water on both sides of the meter.

**EXPLANATION :** For the avoidance of doubts, it is hereby declared that water meters are intended to be used where the supply of water is continuous. Consequently, the water meter should not be used where the supply of water is discontinuous because in such a case, the meter is likely to give wrong readings on account of the passage of air through the pipe line.

## 10. SEALING

Every water meter shall be provided with a suitable sealing arrangement to receive the seal of the verification authority.



## APPENDIX 'A'

## METHODS FOR DETERMINATION OF LOSS OF HEAD IN WATER METERS

(i) Pressure gauge or manometers shall be fixed upstream and downstream of water meter under test. The inlet and outlet of the water meter shall each be provided with a straight pipe of internal diameter equal to the nominal size of the meter and having length equal to at least 10 times its diameter free from tees, bonds, valves, etc. and the meter in no case shall freely discharge into the atmosphere. The internal surface of the pipe shall be smooth and shall not offer any obstruction to the flow of water. When discharging water at the specified rates [see 6(c) and 6(d)] the pressure drop shall be noted which shall be the loss of head at the corresponding flows.

(ii) The needle valve shall be situated at a distance not less than 40 times the diameter of the pipe from the inlet end of the water meter. When the feed of the water is through a pump instead of through an overhead tank, the pump shall be so situated and where required suitable damping devices, such as air vessels or automatic pressure switches shall be so provided that the pulsations in the flow of water through the meter is reduced to the minimum.

## PART 3

## METERS FOR LIQUIDS (OTHER THAN WATER)

## 1. GENERAL

(a) This part deals with meters for liquids (other than water) in which the liquid being measured causes the displacement of movable walls defining the limits of the measuring chambers which allow continuous measurement of any volume of liquid.

(b) The expression "meter" designated an instrument consisting only of a "measuring device" and an "indicating device".

(c) Auxiliary devices for meters, as well as measuring assemblies are the subject of another part.

## 2. DEFINITIONS

(a) **Minimum delivery**—Minimum delivery is the smallest volume of liquid authorised to be measured through the meter.

(b) **Cycle Volume**—Cyclic volume is the volume of liquid corresponding to one cycle of operation of the measuring device *i.e.* the sequence of movements at the completion of which all the internal moving parts of the measuring device return for the first time, to the same position as the beginning of the operation.



(c) **Periodic variation**—Periodic variation is the maximum difference which occurs, during one cycle of operation between the volume cleared by the displacement of the measuring parts and the corresponding volume recorded by the indicator, the latter being connected without play, or slip to the measuring device in such a manner that it indicates at the completion of the cycle, and for that cycle, a volume equal to the cyclic volume. This variation may be reduced by the introduction of an appropriate correcting device.

(d) **Primary element of an indicating device**—In an indicating device having several elements, that element which carries the scale having the minimum graduation is called “the primary element”.

### 3. INDICATING DEVICE :

#### (a) General Provisions

- (i) The indicating device, which may have one or more moving elements, shall indicate the measured volumes in cubic centimetres or millilitres, in cubic decimetres or litres, or in cubic metres.
- (ii) The reading shall be indicating clearly, quickly and unambiguously. If the device has several elements, the assembly shall be carried out in such a manner that the final reading may be obtained by simple juxtaposition of the readings of different indicating elements.
- (iii) The minimum graduation of the primary element shall be  $1 \times 10^n$  or  $2 \times 10^n$  or  $5 \times 10^n$  times the units of volume.
- (iv) The maximum capacity of the indicator shall be  $1 \times 10^n$  or  $2 \times 10^n$  or  $5 \times 10^n$  times the units of volume.
- (v) When the graduation of an element is completely visible the value of one revolution of this element shall be  $10^n$  times the units of volume. This principle does not, however, apply to the element which corresponds to the maximum capacity of the indicator.
- (vi) On a device having several elements, the value of each revolution of the moving parts of the elements, the graduation of which is totally visible, shall be equal to the value of the minimum graduation of succeeding elements.



**(b) Method of indication**

- (i) An element of the indicating device may be analogue or digital, but when elements other than the primary, have only a portion of their scale visible through windows, those elements shall have digital movement (the primary element may, however, be analogue or digital).
- (ii) An element with analogue movement shall have a graduated scale and a pointer to indicate the measured volume at any position of stop.
- (iii) When that element is in the form of fixed circular scale and rotating needle indicator, the direction of the rotation of the needle shall be clockwise.
- (iv) In an indicating device having several elements, the advancement of figures of an element with digital movement, other than the primary, shall stop when the preceding element indicates zero. This advancement shall occur when the preceding element makes a fractional rotation not greater than one-tenth.
- (v) If the indication is given in aligned numbers and the movement of the primary element is digital, the presence of one or more zeros fixed to the right of that element is authorised.

**(c) Graduation**

- (i) Graduation lines on scales shall be of uniform thickness throughout their length. Their thickness shall be not more than quarter of the length of the graduation.
- (ii) The graduation representing  $1 \times 10^n$ ,  $2 \times 10^n$ , or  $5 \times 10^n$  of the units of volume shall be differentiated by their length.
- (iii) The length of the graduation as actually marked or optically magnified, shall be not less than 4 mm.
- (iv) The height of the numerals, as actually marked or optically magnified, shall be not less than 4 mm.
- (v) If the primary element has analogue movement and has a moving scale of which only a portion is visible through the window, the width of such window, in the direction of the scale, shall be not less than 1.5 times the distance between two consecutive numbered graduations. The scale, shall be not less than 1.5 times the distance between two consecutive numbered graduations.

**Note :** The letter 'n' appearing in this part symbolises a whole number, positive, negative or zero.

**(d) Operation of mechanical indicator**—The operation of the indicative device by the measuring device shall be positive and reliable the intermediary of a permanent magnetic device.



#### 4. ADJUSTING DEVICES

(a) The meters shall have an adjusting device to change the ratio between the indicated volume and the actual volume of liquid which has passed through the measuring device.

(b) When the adjusting device changes this ratio in a discontinuous manner, the consecutive values of this ratio shall not differ by more than 0.002.

(c) Adjustment by means of a by-pass pipe on the measuring device is prohibited.

#### 5. SPECIAL PROVISIONS RELATING TO MINIMUM DELIVERY

(a) Minimum delivery shall be determined in such a manner that the maximum permissible error on that delivery (see 8a and 8b) is more than or equal to each of the following values :

(i) (A) if the primary element has analogue movement :

the largest of the volumes corresponding to 2 mm of its scale or to 1/5 of the value of the graduation on that scale;

(i) (B) if the primary element has digital movement volume corresponding to two units of graduation;

(ii) twice the periodic variation;

(iii) the volume which, in normal usage, corresponds to the play or slip in the transmission of the motion of the measuring device to the primary element of the indicating device.

(b) The minimum delivery should take into account, where necessary, the influence of auxiliary devices of the measuring assembly in accordance with the provisions of the Part relating to auxiliary devices and measuring assemblies.

(c) The value of the minimum delivery, determined by the application of the above rules, shall be of the form  $1 \times 10^n$ ,  $2 \times 10^n$  or  $5 \times 10^n$  of a units of volume.

#### 6. MAXIMUM FLOW AND MINIMUM FLOW

(a) The values of maximum and minimum rates of flow of a meter shall be fixed in the light of the results of the model approval tests.

(b) The ratio between the maximum and the minimum rates of flow shall be not greater than 10 for ordinary meter, and not greater than 5 for meters for liquefied gas.

(c) The meter shall be capable of operating in the vicinity of its maximum rate of flow for the period determined in the light of the results obtained in the model approval tests, without noticeably changing any of its meteorological qualities.



## 7. EFFECT OF NATURE OF LIQUID, TEMPERATURE AND PRESSURE

(a) The certificate of model approval of a meter shall indicate and fix:

- (i) the liquid or liquids for the measurement of which the meter shall be used.
- (ii) temperature limits of the liquid measured if the limits are less than  $-10^{\circ}\text{C}$  or more than  $+50^{\circ}\text{C}$ .
- (iii) the maximum operating pressure of the instrument.

(b) The models of meters submitted for approval shall be such that the variations of their errors due to:

- (i) the maximum variations of the characteristics of liquids to be measured.
- (ii) the maximum variations of the temperature of the liquids to be measured.
- (iii) the maximum variations in operating pressure (these variations remaining within the limits fixed by the decision of approval referred to in 7(a) above), shall not exceed, for each of these factors, half the values of the maximum permissible errors specified in 8(a) and 8(b) below.

## 8. MAXIMUM PERMISSIBLE ERRORS ON VERIFICATION OF MEASURING ASSEMBLY

(a) Under the normal conditions of use the maximum permissible errors on the verification of the measuring assembly shall be as given below:

Quantities measured	Maximum permissible errors.
From 0.02 to 0.1 litre	$\pm 2$ ml
From 0.1 to 0.2 litre	$\pm 2$ per cent of the quantity measured.
From 0.2 to 0.4 litre	$\pm 4$ ml
From 0.4 to 1 litre	$\pm 1$ per cent of the quantity measured.
From 1 to 2 litre	$\pm 10$ ml
From 2 litre or more	$\pm 0.5$ per cent of the quantity measured.

(i) The maximum permissible error on the minimum delivery shall be double the error specified in (a) above, for the quantity corresponding to that delivery.

(ii) Whatever the volume measured, the maximum permissible error shall not be less than that permitted on the minimum delivery.



(b) Because of the special difficulties of control, the maximum permissible error as applied to :

- (i) measuring assembly for liquefied gas;
- (ii) measuring assembly for liquids measured at a temperature less than  $-10^{\circ}\text{C}$  or more than  $+50^{\circ}\text{C}$ ;
- (iii) measuring assembly with a minimum rate of flow of less than 1 litre per hour, shall be double those specified under 8(a).

(c) If, in the flow range of the measuring assembly, the errors due to variation in the rate of flow, when a specified quantity is measured, are all in the same sense, one of these errors shall at least be less than or at the most equal to the greater of the following two values :

- (i) half the maximum permissible errors specified above for the quantity measured; or
- (ii) 0.3 per cent of the quantity measured.

## 9. MARKINGS

Every meter shall bear the following markings : on the dial of the indicating device or on a conspicuous name plate :

- (a) the name and trade mark, if any, of the manufacturer, and his address,
- (b) identification number and year of manufacture,
- (c) number of model approval,
- (d) nature of the liquid or liquids to be measured and the limits of kinematic or dynamic viscosity, if the indication of the nature of the liquids is inadequate to characterise their viscosity.

**Note:** The kinematics viscosity shall be expressed in square metres per second and the dynamic viscosity in Newton seconds per square metre.

- (e) maximum and minimum rates of flow,
- (f) maximum operating pressure,
- (g) temperature interval, if the liquid has to be measured temperature less than  $-10^{\circ}\text{C}$  or more than  $+50^{\circ}\text{C}$ .

**(h) Cyclic volume :**

(i) On the dial of the indicator device shall be marked the units in which the volumes measured are expressed, and the minimum delivery.

(ii) These inscriptions shall be clearly legible and indelible under normal conditions of use of the meters.

(iii) The indicating device shall carry a designation and an identification number specific to that device.

(iv) If there is a possibility of confusion, the direction of flow of liquid shall be indicated by a narrow on the casing of the measuring device.

(v) On dismantlable metres for edible liquids, the identification number of the meter (or the last three digits of that number) shall be repeated on parts, the exchange of which may affect the result of measurement.

**10. TEST**

Every meter shall be tested for its metering accuracy and shall conform to the requirements specified in paragraph 8.

**11. SEALING**

(a) The meter shall be provided with a place, which is visible without dismantling, on an essential part of the measuring or indicating device or on the housing of these device, to receive the Inspector's stamp.

(b) Meters shall be provided with devices which can be sealed and which prevent, without damage to the protection marks affixed on these seals, access to parts which affect the results of measurement and permit, even partially, dismantling of the meter.

**PART 4****VOLUMETRIC CONTAINER TYPE LIQUID MEASURING DEVICE****1. GENERAL**

The volumetric container type liquid measuring device consists of a bucket, a float and a dip stick suitably graduated in indicate the volume of liquid at different heights in the bucket. The device is generally used for measuring the quantity of milk at milk purchasing centres.

**2. NOMINAL CAPACITIES**

(a) The unit of volume shall be the cubic decimetre or litre; or the cubic centimetre (cm) or millilitre.



(b) The volumetric container type liquid measuring device may be one of the following capacities :  $\text{dm}^3$ ,  $10 \text{ dm}^3$ ,  $20 \text{ dm}^3$ , and  $50 \text{ dm}^3$ .

(c) The value of the smallest graduation on the dipstick shall be of the form of  $1 \times 10^n$ ,  $2 \times 10^n$ , or  $5 \times 10^n$  where 'n' represents a whole number, positive or negative or is equal to zero.

### 3. GENERAL REQUIREMENTS

(a) The bucket shall be made of suitable metal or alloy. The metal or alloy used shall be thermally stable, shall resist deformation, shall not have an unduly high co-efficient of cubical expansion, and shall not affect the liquid being measured in any way or be injurious to health. Some of the materials considered suitable are :

- (i) mild steel,
- (ii) stainless steel
- (iii) brass sheet,
- (iv) copper sheet,
- (v) aluminium alloy.

(b) The wall thickness of the bucket shall be selected that the bucket will not get dented in normal use or become unusable after a few years in service.

(c) The bucket shall be free from surface defects and indentation. External and internal surfaces of the bucket made of mild steel copper sheet and brass sheet shall be well tinned or tin plated.

(d) All seams shall be filled and smoothed to prevent the entrapment of air or liquid.

(e) The bucket shall be provided with a well formed and proportionate spout to facilitate pouring of liquid.

(f) The bucket shall be cylindrical in form. The bottom of the bucket shall be slightly concave to prevent change of shape due to the weight of the liquid. The maximum depth of the concavity shall not be more than 20 mm.

(g) Bottom of the bucket shall be reinforced with angle strip of thickness not less than 5 mm.

(h) The upper edge of the bucket shall be reinforced round the circumference with a reinforcing band having a thickness not less than 5 mm.



- (i) The bucket shall be provided with a suitable handle on the side opposite the spout.
- (j) The top of the bucket shall be provided with a cross band across the diameter. The band shall have groove of appropriate size and centrally located for inserting the dip stick.
- (k) The float shall be suitably fabricated so as to be free from holes, pockets, dents or crevices. A dip stick shall be firmly welded on the upper centre of the float. The dip stick together with the float shall be so constructed that the device so formed maintains verticality in all positions.
- (l) The dip stick shall have a rectangular cross-section of minimum dimensions 20 mm × 10 mm. The graduations shall be made by engraving or other means on both sides of the vertical surface.
- (m) The dip stick shall be graduated at suitable intervals throughout the nominal capacity of the measure.
- (n) The graduation lines on the dip stick shall be clear straight, perpendicular to the axis of the stick and of uniform thickness not exceeding 1 mm.
- (o) The dip stick shall be identified with the bucket by a number of identification, which shall be clearly legible and indelible.

#### 4. MARKING

The following inscriptions shall be clearly and indelibly marked at a conspicuous place on the bucket or on a special plate securely attached to the bucket :

- (a) nominal capacity
- (b) manufacturer's name or trade mark,
- (c) the words for "edible liquids".

#### 5. SEALING

A suitable plate or other device shall be provided to receive the stamp or seal of the verification authority.

### PART 5 TAXIMETERS

#### 1. TERMINOLOGY

(a) 'Taximeter'—A measuring instrument which totalizes continuously and indicates at any movement of the journey the charges payable by the passenger of a public vehicles as function of the distance travelled and, below a certain speed, of the length of time occupied, independent of supplementary charges, according to the authorised tariffs.

(b) **Basic distance tariff**—The tariff for distance corresponding to all the intervals except the initial interval.



(c) **Basic time tariff**—The tariff for time corresponding to all the intervals except the initial interval.

(d) **Cleared**—A taximeter is cleared when no indication of fare is shown and when all parts are in the positions in which they are designed to be, when the vehicle on which the taximeter is installed is not engaged by a passenger.

(e) **Reading face**—The side of a taximeter upon which the indications interest to the passenger are indicated.

(f) **Fare**—That portion of the charge for the hire of a vehicle that is automatically calculated by a taximeter through the operation of the distance of time mechanism.

(g) **Flag**—A device by which the operating conditions of a taximeter is controlled.

(h) **Initial distance or time interval**—The interval corresponding to the initial money drop.

(i) **Money drop**—An increment of fare indication.

(j) **Initial money drop**—The initial charges appearing on the reading face of the taximeter at the time when it is hired by passenger.

(k) **Distance of time intervals**—The intervals corresponding to money drops following the initial money drop.

(l) **Constant 'k' of the taximeter**—The constant k of a taximeter is a characteristic quantity showing the type and number of signals which the instrument must receive in order to indicate correctly a covered distance of 1 km.

**This constant 'k' is expressed—**

(i) in 'revolutions per indicated kilometer' (rev/km.) if the information relating to the distance covered by the vehicle is introduced into the taximeter in the form of a number of revolutions of its main shaft (drive shaft at entry point to the instrument).

(ii) in 'impulse per indicated kilometer' (imp/km.) if this information is introduced in the form of electrical signals.



According to the construction of the instrument the constant 'k' may be fixed or may be adjustable by fixed amounts.

**(m) Characteristic coefficient 'w' of the vehicle**—The characteristic co-efficient 'w' of a vehicle is a quantity indicating the type and number of signals intended to drive the taximeter which appear at the component provided for this purpose, for a distance travelled of 1 km.

**This co-efficient 'w' is expressed:**

- (i) in revolutions per kilometer travelled (rev/km.); or
- (ii) in 'impulse per kilometer traveled' (imp/km.) depending on whether the information relating to the distance travelled by the vehicle appears in the form of a number of revolutions of the component driving the taximeter or in the form of electrical signals.

This co-efficient varies as a function of several factors, principally the wear and pressure of the tyres, the load carried by the vehicles, the conditions under which the vehicle makes a journey. It shall be measured under the standard test conditions for the vehicle.

**(n) Adapting device**—A special device which allows the values of 'k' and 'w' to be adjusted in such a way that maximum permissible error laid down in paragraph 5(e) shall not be exceeded.

## 2. GENERAL

(a) The following units of measurements shall be used for taximeters (i) the metre or kilometer for distance (ii) the second, minute or hour for time.

(i) The fare for the journey shall be expressed in the legal monetary units.

## 3. TECHNICAL CHARACTERISTICS

**(A) General Constructional Features :—**

(a) The taximeter shall be robust and well constructed. The functional of the taximeter shall be made of materials which guarantee adequate strength and stability.

(b) The casing of the taximeter and that of the adapting device as well as the covers of the transmission devices shall be so made that the essential parts of the mechanism are out of reach from outside and are protected against dust and humidity.

Access to devices for adjustment shall be made impossible without damage to the sealing arrangements.



(c) In the case of electronic taximeters, the electronic devices which calculate the charge payable shall operate without failure, and at any time it shall be possible to check their correct operation. This may be achieved by means of a special control programme which is automatic or manually activated.

Any fault identified by this control programme shall be clearly indicated.

### **B. Measuring Device—Calculating Device.**

(a) Except when the taximeter is being cleared, indications of fare shall be clearly visible at all times.

(b) The taximeter shall be so designed that it calculates and indicates the fare for the journey solely on the basis of :

(i) The distance travelled when the vehicle moves at a speed higher than the changeover speed; or

(ii) The period of time when the vehicle moves at a speed less the changeover speed. The changeover speed is attained by dividing the time tariff by the distance tariff and may vary according the variation in these tariffs.

(c) The distance drive shall be made through the medium of the wheels, and the reverse motion shall not cause a reduction in the fare or distance shown.

(d) The time drive shall be obtained by a mechanical or electronic movement of the clockwork, which can be activated only by operating the mechanism of the taximeter.

(e) If the working of the clockwork mechanism is operated by manual winding, it shall work for at least 8 hours without rewinding or for at least two hours if rewinding is necessary at each manual operation before it is set in operation.

The electronic clockwork, shall be capable of functioning at any time.

(f) During the distance drive, the first increment of fare indication (money drop) shall occur after travelling the initial distance. The subsequent money drops shall correspond to equal distance between each of them.

(g) During the distance drive, the first increment of fare indication (money drop) shall occur after the initial time interval. The subsequent money drops shall correspond to equal time intervals between each of them.



(h) Without change of drive, the ratio between the initial distance and the subsequent distances shall be the same as the ratio between the initial time and subsequent time intervals.

(i) An adapting device, situated inside or outside the instrument case, shall allow the adaptation of the taximeter constant to the characteristic co-efficient of the vehicle on which it is mounted, with an accuracy such that the maximum permissible errors laid down in paragraph 5(c) shall not be exceeded.

(j) The taximeter shall be so designed as to facilitate necessary adjustment of the calculating device for making it conform to the changes in the tariff.

(k) If the number of tariffs provided on the instrument is greater than the number of tariffs in force, the taximeter shall, in the superfluous positions, calculate and indicate a fare based on one of the authorised tariffs.

### (C) Control Mechanism —

(a) The mechanism of the taximeter shall be capable of being set in motion after having been engaged by a single control mechanism.

For the electronic taximeter this mechanism may consist of various push buttons and switches for special operations.

The mechanism of the taximeter shall be capable of being set in motion in one of the positions indicated in clauses (b), (c) and (d).

### (b) FREE POSITION (FOR HIRE)

#### In this position—

(i) There shall be no indication of the fare to be paid or, this indication shall be equal to zero or to a value of the initial money drop but in the latter case, the indication shall be covered by a shutter;

(ii) The distance drive and the time drive shall not operate the device which indicates the fare to be paid;

(iii) The totalizer indicating the total distance travelled shall remain turned off;

(iv) The window through which possible extras are seen shall be blank or indicate "Zero".

(c) "WORKING" POSITION (HIRED)—In this position, the time and distance drives and the extras indicator, if any shall be engaged;

(d) "TO PAY" POSITION.—In this position, which shows the final total fare due from the passenger for the journey excluding any extras, the time drive shall be disconnected and the distance drive shall remain connected to the authorised tariff.



In case of electronic taximeter it is permitted, by operating a special button in the TO PAY position, to add any possible extras to the fare, and to indicate on the indicator, the total fare payable by the passenger. When this button is released the two amounts shall be indicated separately.

(e) The control mechanism, shall be so designed that starting from FREE position, the taximeter can be set successively in WORKING position and TO PAY position.

(f) The operation of the control mechanism is subject to the following restrictions :

(i) Starting from the WORKING position, it shall not be possible to put the taximeter, back in the 'FREE' position without going through the 'TO PAY' position.

(ii) Starting from the TO PAY position, it shall not be possible to put the taximeter in the WORKING position without going through the FREE position.

#### **(D) Indicating Device.—**

(a) The "reading face" of the taximeter shall be so designed that the indications of interest to the passenger can be easily read by him.

(b) The fare to be paid, excluding possible extras, shall be ascertained from the fare indicator by simple reading of an indication in aligned figures having a minimum height of 10 mm.

When electronic indicating elements are used it shall be possible to check the operation of the indication.

(c) As soon as the instrument is put into operation from the FREE position by operating the control mechanism, the shutter, if any covering the indication of fare to be paid, shall retract and a fixed amount corresponding to the initial money drop shall appear.

The fare indicator shall thereafter advance by successive steps of a constant monetary value, as soon as the amount of the initial money drop has been used up.

(d) The taximeter shall be provided with a device indicating at any moment on the reading face the engaged working position.

(e) The taximeter shall have a means for illuminating the readings appearing on the reading face and it shall be possible to replace the light bulbs without opening the sealed parts of the meter.

In the case of self-luminous indications no additional illumination is required if readability of the indications of interest to the passenger is ensured.



**(E) OPTIONAL ADDITIONAL DEVICES.—**

The taximeter may in addition be provided with supplementary devices, such as—

(a) an indicator of extras independent of the fare indicator mentioned in clause 3(D) (b) and automatically returning to zero in the FREE position. In the TO PAY position it is permitted to add the extras to the fare by operating a push button.

(b) totalizers which give, in aligned figures having a minimum height of 4 mm, indications of—

- (i) the total distance travelled by the vehicle;
- (ii) the total distance travelled on hire;
- (iii) the total number of “engagement”;
- (iv) the total number of money drop.

The totalizers may be also non-erazable electronic memories which can be recalled and indicated in the FREE position of the taximeter. The date in the memory shall be protected for at least 72 hours after a power supply failure.

(c) A device detecting the presence of a passenger (pressure sensor)

**4. INSCRIPTION**

(a) Every taximeter shall bear the following indications :

- (i) name and address of the manufacturer or his trade mark;
- (ii) the constant ‘K’ in rev/Km. or imp/km.

(b) Every taximeter shall have places to permit :—Affixation of marks of initial and period:cal verifications.

(c) In the vicinity of the windows of all indicating devices the meanings of the values shown shall be given clearly legibly and unambiguously.

(d) The name or the symbol of the monetary unit shall be alongside the fare indication for the journey and the indication of extras to be paid.

**5. MAXIMUM PERMISSIBLE ERRORS**

(a) During drive by distance the maximum dispersion of the indications shall not exceed :

(i) for the initial distance 2% of the true value. However, for initial distances less than 1000 meters, the dispersion may be up to 20 meters;

(ii) for distance succeeding the initial distance 2% of the true value.



(b) During drive by time the maximum dispersion of the indications shall not exceed—

(i) for the initial time : 3% of the true value however, for initial times less than 10 minutes, this error may be up to 20 seconds.

(ii) for times succeeding the initial time 3% of the true value.

(c) the adoption shall be carried out under the standard test conditions such that the constant 'K' of the taximeter differs by less than 1% from the characteristic number 'W' of the vehicle on which it is mounted.

## 6. PROTECTION AND GUARANTEE SEALS

(a) The under mentioned part of the taximeter shall be so constructed that they can be sealed with lead or by marks of protection and guarantee :

- (i) the case enclosing the internal mechanism of the taximeter;
- (ii) the case of adjusting device (if this device is outside the case of the taximeter);
- (iii) the covers of electrical or mechanical devices forming the connection between the entrance of the taximeter and the corresponding part provided on the vehicle for alignment with the instrument, including the detachable parts of the adjusting device.

(b) A plate of approved size and pattern shall be attached to the taximeter gear box or to the taximeter itself in such a manner that it cannot be removed without either removing the seals affixed by the testing authority or opening the taximeter or taximeter gear box. The plate shall show in raised or sunken words and figures, the type of cab on which the taximeter is to be used.

These seals shall be such that all access to protected components particularly the components of adjustment is impossible without damaging the seal.

## 7. STANDARD TEST CONDITIONS FOR THE VEHICLE

(a) The load carried by the vehicle corresponds to the weight of five adult persons including the driver.

(b) The tyres are inflated to the pressure prescribed by the vehicle manufacturer and are in good condition (e.g. conforming to the road safety rules).

(c) The vehicle is moving, under its own power, on level ground in a straight line, at a speed less than 40 Km/h.

## 8. TEST METHODS

To determine compliance with distance tolerances a distance test of the taximeter shall be conducted utilizing any one of the following test methods :—

(a) **Road Test Method**—A road test consists of driving the vehicles over a precisely measured road course.

(b) **Fifth Wheel Test Method**—The test consists of driving the vehicle over any reasonable road course and determining the distance actually travelled through the use of a mechanism known as “fifth wheel” that is attached to the vehicle and that independently measures and indicates the distance.

(c) **Simulated Road Test Method**—This test consists of determining the distance travelled by computation from rolling circumference & wheel turn data.

## 9. TEST PROCEDURE

(a) The distance test of a taximeter, whether (a), (b) or (c) shall include at least duplicate runs of sufficient length to cover at least the third money drop or one km, whichever is greater, and shall be at a speed approximating the average speed travelled by the vehicle in normal service.

(b) If the taximeter is equipped with a mechanism through which charges are made for time intervals, a test shall be conducted to determine whether there is interference between the time and distance mechanism. During this test, the vehicle is operated at a speed of 3 or 4 km/h faster than changeover speed.

## PART-6

### VOLUMETRIC GAS METERS

#### 1. Field of application

The volumetric gas meters are as follows :

##### 1.1 Positive displacement meters :

meters with a liquid seal,  
diaphragm meters,  
rotary piston meters.

##### 1.2 Inferential meters :

turbine meters.

It prescribes the general requirements which all these meters must meet. Supplementary provisions will be prescribed for the above listed meters.



## **2. Construction**

### **2.1 Materials**

The meters must be made of sound materials, without internal stresses, changing little with age and sufficiently resistant to corrosion and to the attacks of various gases normally circulated and their condensates.

### **2.2 Soundness of the cases**

The cases of meters must be gas-tight at the maximum working pressure of the meters.

### **2.3 Protection against external interference**

The meter must be constructed in such a way that any interference capable of affecting the measuring accuracy is impossible without damaging the verification or protection marks.

### **2.4 Direction of the gas flow**

On meters where the indicating device registers positively for one direction of the gas flow, this direction must be indicated by an arrow; this arrow is not required if the direction of the gas flow is determined by the construction.

The device preventing normal functioning of the measuring device when the gas flow is in the opposite direction to that intended for measuring.

### **2.5 Metrological properties**

At a flow rate equal to  $Q_{max}$ , a meter must be able to work continuously for a time fixed by the changes in its metrological properties exceeding the limits fixed by these requirements.

## **3. Additional devices**

**3.1** Meters may be provided with additional devices (correcting device, recording device, supplementary indicating device, etc); their addition is subject to the pattern approval procedure.

**3.2** Meters may be provided with special transmission shafts (output drives) projecting from the casing to drive a detachable indicating device, a prepayment device, or any other additional device.

**3.2.1** When these drives are not used, the free end of the drive must be protected by a plug or by a similar accessory which can be sealed.

3.2.2 These shafts must be marked with the value of their constant in the form : « 1 rev ^ ...m<sup>3</sup> (or dm<sup>3</sup>) ».

3.3 Meters may incorporate pulse generators. The output connections of these pulse generators must be marked with the value corresponding to one pulse in one of the following forms :

« 1 pulse ^ ....m<sup>3</sup> (or dm<sup>3</sup>) ^ ...pulse ».

#### 4. Inscriptions

4.1 Each meter must bear, in a group, either on the index plate, or on a special data plate, the following inscriptions :

- a—the approval sign of the meter, if appropriate (\*),
- b—the marker's trade mark of his trade name,
- c—the number of the meter and its year of manufacture,
- d—the designation of the meter, this designation is in the form of the capital letter G, followed by number of fixed,
- e—the maximum flow rate by the formula : Q<sub>max</sub>....m<sup>3</sup>/h,
- f—the minimum flow rate by the formula : Q<sub>min</sub>....m<sup>3</sup>/h (or dm<sup>3</sup>/h)
- g—the maximum working pressure by the formula : P<sub>max</sub>....MPa (or kPa or Pa or bar or mbar),
- h—for volumetric meters, the nominal value of the cyclic volume by the formula : V.....m<sup>3</sup> (or dm<sup>3</sup>),
- i—if required, the commercial designation of the meter, a special serial number and the name of the gas distributor.

These inscriptions must be directly visible, easily legible and indelible under normal conditions of use of the meters.

4.2 The other indications, in particular, the nature of the gas to be measured.

4.3 Without special authorization, any other indication or inscription is prohibited.

#### 5. Indicating devices and test element

##### 5.1 Indicating device

5.1.1 The indicating devices must consist of drums (\*); the last element, however, (i.e. the one with the smallest scale interval) may be an exception to this rule.



The drums must be numbered in cubic meters or in decimal multiples or sub-multiples of the cubic metre.

The symbol « m<sup>3</sup> » must be appear on the index plate.

**5.1.1.1** In the case the indicating device includes drums numbered in decimal sub-multiples of the cubic metre, these drums must be separated by a clear decimal marker from those numbered in cubic metres, and the decades after the decimal marker must be clearly distinguished from those in front of it.

**5.1.1.2** In the case where the last drum is numbered in a decimal multiple of the cubic metre, the index plate must bear :

a-either one (or two, or three, etc....) fixed zero after the last drum,

b-or the indication « x 10 » (or « x 100 », or « x 1000 » etc....), so that the reading is always in cubic metres.

**5.1.2** The indicating device must have enough numbered drums to be able to indicate, to within one unit of the last drum, the volume delivered during 1000 hours working at maximum flow rate.

(\*) It appears that in certain Member Countries the mandatory use of indicating devices with drums causes, at present, great difficulty. In consequence, these Member Countries will, provisionally, be in need of requirements for indicating devices with pointers. It is recommended that they apply for this purpose the requirements in Appendix A of this Recommendation.

## 5.2. Test element

**5.2.1** Meters must be designed in such a way that verification can be effected with sufficient accuracy.

For this purpose they must be constructed either with an integral test element or with arrangements permitting the connection or a portable test unit.

**5.2.2** The integral test element may consist of the last element of the indicating device in one of two following forms :

a-a continuously moving drum bearing a graduated scale,

b-a pointer moving over a fixed dial with a graduated scale, or a disc with a graduated scale moving past a fixed reference mark.



5.2.2.1 On the numbered scales or the test elements referred to in point 5.2.2.b. the value of one complete revolution of the pointer must be indicated in the form : : "1 rev<sup>n</sup> .....m<sup>3</sup> (or dm<sup>3</sup>)". The beginning of the scale must be indicated by the figure zero.

5.2.2.2 The scale spacing must not be less than 1 mm and must be constant throughout the whole scale.

5.2.2.3 The scale interval must be in the form  $1 \times 10^n$ ,  $2 \times 10^n$ , or  $5 \times 10^n$  (n being a positive or negative whole number or zero).

5.2.2.4 The graduation lines must be fine and uniformly drawn.

In the case where the scale interval is in the form  $1 \times 10^n$ , or  $2 \times 10^n$ , all the lines representing multiples of 5, and in the case where the scale interval is in the form  $4 \times 10^n$ , all the lines representing multiples of 2, must be distinguished by a longer line.

The index must be sufficiently fine to permit accurate and easy reading.

5.2.2.5 The test element may be provided with a scale mark which stands out in contrast to the scale and is of sufficient size to allow photoelectric scanning. This scale mark must not obscure the graduation; if appropriate, it may replace the figure zero. This scale mark must be detrimental to the accuracy of reading.

### 5.3 Diameter of drums and dials

The diameter of the drums must be at least 16 mm.

The diameter of the graduated scale referred to in point 5.2.2.b. must be at least 32 mm.

### 5.4 Reading of the indicating device

The indicating device must be so designed that the principle of reading by simple just a position is respected.

### 5.5 Advance of the figures

The advance by one unit of a figure of any order must take place completely while the figure of an order immediately below passes through the last tenth of its course.

### 5.6 Removal of the indicating device

The meters must be so designed that the indicating device may easily be removed during verification.



## 6. Maximum permissible errors

6.1 Errors of measurement are expressed in relative values by the ratio (expressed as a percentage) of the difference between the indicated value and the conventional true value of the volume of air, which has passed through the meter, to this latter value :

$$\text{error in \%} = \frac{\text{indicated volume} - \text{conventional true volume}}{\text{conventional true volume}}$$

6.2 These errors relate to the measurement of volumes of air having a reference density of 1.2 kg/m<sup>3</sup>(\*).

6.3 The values of the maximum permissible errors are fixed by the rules, they are valid for the authorized directions of flow.

## 7. Pressure absorption

### 7.1 Maximum permissible values

The maximum permissible values of pressure absorption are fixed by the rules.

---

(\*) In normal atmospheric conditions, it can be considered that the ambient air of a verification laboratory meets this condition.

## 8. Location of verification and protection marks

### 8.1 General remarks

Location of the marks must be chosen in such a way that the dismantling of the part sealed by one of these marks entails damaging this mark.

#### 8.1 Data plate

Meters must have a special location for applying a verification mark; removal of the data plate must be impossible without damaging this mark.

#### 8.2 Other locations

Location for verification or protection marks must be provided on every meter :

- a—On all plates which bear information prescribed by this rules.
- b—On all parts of the casing which cannot be otherwise protected against interference likely to affect the accuracy of measurement.

## 9. Subjection to metrological control

### 9.1 Pattern approval

9.1.1 Each model of meter from each manufacturer is subject to the pattern approval procedure.

9.1.2 Without special authorization, no modification may be made to an approval model.

### 9.2 Initial verification

New meters are subject to the initial verification procedure. They must comply with the requirements relating to this verification.

These requirements apply equally on subsequent verifications of repaired or readjusted meters.

### 9.3 Periodic verifications

Periodic verifications will be made to see if meters in service retain their metrological properties.

## APPENDIX A

### 5.A Indicating devices with pointers

5.A.1 The face of an indicating device with pointers must have circular scales intended for reading the volumes of measured gas, each graduated into 10 divisions of the same length. The scale marks must be numbered successively from 0 to 9, the "0" scale mark being at the top of the scale. The diameter of the circular scales is at least equal to 16 mm.

The face must have enough numbered circular scales to indicate the volume delivered during 1000 hours working at maximum flow rate.

The symbol "m<sup>3</sup>" must be provided on the dial.

5.A.2. The intermediate transmissions of the indicating device with a pointer must be so arranged that the direction of rotation of the pointers of circular scales alternates when one considers the next circular scale of which the value, in volume, must be ten times greater or ten times smaller.

5.A.3. The pointer moving at the highest speed must be located on the right hand side of the indicating device when viewed by an observer standing in front of the meter. The direction of rotation of this pointer must be clockwise. The value of a complete revolution of this pointer must correspond to 10 m<sup>3</sup>, 100m<sup>3</sup>, etc.



**5.A.4.** Each numbered circular scale must indicate clearly and non-ambiguously the value, in units of volume, corresponding to one complete revolution of its pointer. The direction of rotation of the pointer must be indicated by means of an arrow.

**5.A.5.** Circular scales not intended to indicate the volume of gas measured for use (e.g. intended for the verification of the meter or the control of its metrological qualities) are authorized. However, these scales must be located outside the geometric line on which the circular scales used for indicating the volumes of measured gas are aligned.

A circular scale not intended to indicate the volume of gas measured for use must carry, within the circle, a clear indicating of the value of the volume corresponding to one complete revolution of the pointer. The scale must have 10 divisions of the same length, the scale marks not being numbered. An arrow must indicate the direction of rotation of the pointer.

## Part-7

### A.C ENERGY METER

#### 0. FOREWORD

**0.1** This Bangladesh Standard (Second revision) was adopted by the Bangladesh Standards and Testing Institution on 20-04-1998 after revised by the Sectorial Committee for Electrical Measuring Instruments and had been approved by the Electro-technical Divisional Committee.

**0.2.** This Standard was first formulated in 1996 and subsequently revised in 1989 and further the second revisions has been undertaken in view of the development in the manufacturing techniques of meter and developments in industries.

**0.3.** This Standard has been finalized after taking into consideration the views and suggestions put forward by representative sections of technologists, manufacturers and utilizing agencies.

**0.4.** For the preparation of this standard assistance has been derived from IEC Publication 521 : 1988 A.C. watt-hour meters (Second revision) and this acknowledged with tanks. To fulfill the mechanical requirements some technical data and information have also been incorporated in this standard.

**0.5.** This Standard is subject to periodical reviews and amendments. If necessary in order to keep pace with the latest industrial and technological innovations. Any suggestions for improvement will be recorded and placed before the Committee in due course.



06. This Standard deals with A.C/Energy Meters, Single phase, two-wire whole current watt-hour meters it consists of the following three parts.

- Part 1: Single phase, two-wire, whole current watt-hour meters, accuracy Class-2
- Part 2: Single phase, two-wire, whole current watt-hour meters, accuracy Class-1
- Part 3: Single phase, two-wire, whole current watt-hour meters, accuracy Class-0.5

07. This Standard is intended chiefly to cover the technical provisions relating to the supply of materials and performance and it does not include all the necessary provisions a contract.

## 1. SCOPE

1.1 This Standard applies only to newly manufactured induction type watt-hour meters of accuracy Class 2, for the measurement of alternating current electrical active energy of a frequency in the range 45 Hz to 65 Hz and it applies to their type test only.

It applies to the assembly of meters and accessories, including current transformers when enclosed in the meter case. It does not apply to maximum demand indicators. It does not apply to the following :

- (a) Any kind of measuring device such those used for telemetering electrical energy.
- (b) Meters for testing purposes or to special type of watt-hour meters.

1.2 (a) For meters of outdoor use additional requirements as specified in 5.2.1 and will be necessary.

(b) for portable meters additional requirements may be necessary.

## 2. APPLICATION

2.1 This Standard applies to the meter for the measurement of an electrical active energy used in domestic and small industrial premises and commercial purposes.

It applies to the meters for both indoor and outdoor use.

## 3. TERMINOLOGY

3.0 For the purpose of this Standard the following definitions shall apply :

3.1 **Watt-hour meter**—An instrument intended to measure active energy by integrating active power with respect to time.



**3.2 Induction meter**—A meter in which currents in fixed coils react with the currents induced in the conducting moving element, generally a disk, which causes its movement.

**3.3 Meter rotor**—The moving element of the meter upon which the magnetic fluxes of fixed windings and of braking elements act and which operates the register.

**3.4 Meter driving element**—A working part of the meter which produces a torque by the action of its magnetic fluxes upon the currents induced in the moving element. It generally comprises electromagnets with their control devices.

**3.5 Meter braking element**—The part of the meter which produces a braking torque by the action of its magnetic flux upon the currents induced in the moving element. It comprises one or more magnets and their adjusting devices.

**3.6 Register of a meter (counting mechanism)**—The part of a meter which enables the measured value to be determined.

**3.7 Meter base**—The back of the meter by which it is generally fixed and to which are attached the frame, the terminals or the terminal block and the cover. For a flush mounted meter, it may include the sides of the case.

**3.8 Meter socket**—An enclosure with jaws to accommodate terminals of a detachable watt-hour meter and which has connectors from the termination of the circuit conductors. It may be a single-position socket for one meter or a multiple-position socket for two or more meters.

**3.9 Meter cover**—The enclosure on the front of the meter made either wholly of transparent material or of opaque material provided with window(s) through which the movement of the rotor can be seen and the register can be read.

**3.10 Meter case**—This comprises the base and the cover.

**3.11 Meter frame**—The part to which are affixed the driving elements. The rotor bearings, the register, usually the braking element and sometimes the adjusting devices.

**3.12 Accessible conducting part**—A conducting part which can be touched by the standard test finger, when the meter is installed ready for use.

**3.13 Protective earth terminal**—The terminal connected to accessible conducting parts of a meter, for safety purposes.



**3.14. Terminal block**—A support made of insulating material on which all or some of the terminals of the meter are grouped together.

**3.15. Terminal cover**—A cover which covers the meter terminals and generally, the ends of the external wires or cables connected to the terminals.

**3.16. Current circuit**—A winding of the driving element and the internal connections of the meter through which flows the current of the circuit to which the meter is connected.

**NOTE :** When the meter incorporates a current transformer, the current circuit also includes the transformer windings.

**3.17. Voltage circuit**—The winding of the driving element and internal connections of the meter, supplied with the voltage of the circuit to which the meter is connected.

**3.18. Auxiliary circuit**—The elements (windings, lamps, contacts, etc.) and connections of an auxiliary device within the meter case intended to be connected to an external device, clock, relay, impulse counter.

**3.19. Basic current  $(i_b)$** —The value of current in accordance with which the relevant performance of the meter is fixed.

**3.20. Rated maximum current  $(I_{max})$** —The highest value of current at which the meter purports to meet the accuracy requirements of this standard.

**3.21. Reference voltage\***—The value of voltage in accordance with which the relevant performance of the meter is fixed.

**3.22. Reference frequency**—The value of frequency in accordance with which the relevant performance of the meter is fixed.

**3.23. Basic speed**—The nominal speed of rotation of the rotor expressed in revolutions per minute when the meter is under reference conditions and carries basic current at unity power-factor.

**3.24. Basic torque**—The nominal value of the torque on the rotor when at rest, when the meter is under reference conditions and carries basic current at unity power-factor.

**3.25. Meter constant**—Constant expressing the relation between the energy registered by the meter and the corresponding number of revolutions of the rotor, either in revolutions per kilo-watt-hour (rev/kWh) or watt-hours per revolution (Wh/rev).



**3.26. Reference temperature**—The ambient temperature specified for reference conditions.

**3.27. Clearance**—The shortest distance measured in air between conductive parts.

**3.28. Creepage distance**—The shortest distance measured over the surface of insulation between conductive parts.

### 3.29. Insulation

**3.29.1. Basic insulation**—The insulation applied to live parts to provide basic protection against electric shock.

**NOTE :** Basic insulation does not necessarily included insulation used exclusively for functional purposes.

**3.29.2. Supplementary insulation**—The independent insulation applied in addition to the basic insulation, in order to provide protection against electric shock in the event of a failure of basic insulation.

**3.29.3. Double insulation**—The insulation comprising both basic insulation and supplementary insulation.

**3.29.4. Reinforced insulation**—A single insulation system applied to live parts, which provide a degree of protection against electric shock equivalent to double insulation.

**NOTE :** The term insulation system does not imply that the insulation should be one homogeneous piece. It may comprise several layers which cannot tested singly as supplementary or basic insulation.

**3.29.5. Insulating encased meter of protective Class II**—A meter with a case of insulating material in which protection against electric shock does not rely on basic insulation only, but in which additional safety precaution such as double insulation or reinforced insulation are provided, there being no provision for protective earthing or reliance upon installation conditions.

**3.30. Type**—The term used for defining a particular design of meter, manufactured by one manufacturer, having:

- (a) similar meteorological properties,
- (b) the same uniform construction of parts determining these properties,
- (c) the same number of ampere-turns for the current winding at basic current and the same number of turns per volt for the voltage winding at reference voltage.
- (d) the same ratio of the maximum current to the basic current.

The type may have several values of basic current and several values of reference voltage a combination of letters and numbers. Each type has one designation only.

**NOTES 1.** The type is represented by the sample meter(s) intended for the type tests, and whose characteristics (basic currents and reference voltages) are chosen from the values given in the tables proposed by the manufacturer.

2. Where the number of ampere-turns would lead to a number of turns other than a whole number, the product of the number of turns of the windings by the value of basic current may differ from that of the sample meter(s) representative of the type.

It is advisable to choose the next number immediately above or below in order to have whole numbers of turns.

For this reason only may the number of turns per volt of the voltage windings differ, but by not more than 20% from that of the sample meters representative of the type.

3. The ration of the highest to the lowest basic speed of the rotors of each of the meters of the same type shall not exceed 1.5.

**3.31. Type tests**—Tests carried out to prove conformity with the requirements of this standard these are intended no prove the general qualities and design of a given type of meter.

**3.32. Routine test**—Tests carried out on each meter to check conformity with the requirements of this standard in aspects which are likely to vary during productions.

**3.33. Acceptance tests**—Tests carried out on samples taken from a lot for the purpose of acceptance of the lot.

**3.34. Percentage error**—The percentage error is given by the following formula :

$$\text{Percentage error} = \frac{\text{energy registered by the meter} - \text{true energy}}{\text{true energy}} \times 100.$$

**NOTE :** Since the true value cannot be determined. It is approximated by a value with a stated uncertainty that can be traced to standards agreed upon between manufacturer and user or to national standards.

**3.35. Variation of error due to on influence quantity**—The difference between the percentage error of the meter when only one influence quantity assumes successively two specified value. One of them being the reference value.



**3.36. Influence quantity or factor**—The ratio of the rms value of the harmonic content (obtained by subtracting from a non-sinusoidal alternating quantity its fundamental term) to the rms value of the non-sinusoidal quantity. The distortion factor is usually expressed in percentage.

**3.37. Distortion factor**—The ratio of the rms value of the harmonic content (obtained by subtracting from a non-sinusoidal alternating quantity its fundamental term) to the rms value of the non-sinusoidal quantity. The distortion factor is usually expressed in percentage.

**3.38. Mean temperature co-efficient**—The ratio of the variation of the percentage error to the change of temperature which produces this variation.

**3.39. Vertical working position**—The position of the meter in which the shaft of the rotor is vertical.

**3.40. Class index**—A number which gives the limits of the permissible percentage error, for all values of current between 0.1 ib and 1 max for unity power-factor when the meter is tested under reference condition (including permitted tolerance on the reference values) as defined in this standard.

## 4. CLASS OF METER

### 4.1. Class-2

## 5. MECHANICAL REQUIREMENTS

**5.1. General**—Meters shall be designed and constructed in such a way as to avoid introducing any danger in normal use and under normal conditions, so as to ensure specially :

- Personal safety against electric shock.
- Personal safety against effects of excessive temperature.
- Safety against spread of fire.

All parts which are subject to erosion under normal working conditions shall be effectively protected. Any protective coating shall not be liable to damage by ordinary handling nor injuriously affected by exposure to air, under normal working conditions.

The meter shall have adequate mechanical strength and shall withstand the elevated temperature which is likely to occur in normal working conditions.

The components shall be reliably fastened and secured against loosening.

The electrical connections shall be such as to prevent any opening of the circuit including any overload conditions specified in this standard.

The construction of the meter shall be such as to minimize the risks of short-circuiting of the insulation between live parts and accessible conducting parts due to accidental loosening or unscrewing of the wiring screws etc.



**5.1.1. Materials**—The meter base and frame including terminal block shall be made of heat resistive, shockproof and rustproof good quality hard materials. The meter base shall be made of phonemic resin or steel or diecast aluminium, meter frame shall be diecast aluminium and terminal cover shall be made of stamped metal or molded phonemic resin. The base made of molded phonemic resin or steel will be provided with three sewers mounting holes, one slotted meter support bracket at the top and one round hole on each side in the bottom half of the base for securely mounting the meter to the meter board.

**5.2. Case**—The meter shall have a reasonably dustproof case, which can be sealed in such a way that the internal parts of the meter are accessible only after breaking the seals.

The cover shall not be removable without the use of tool, error or any similar device.

The case shall be so constructed and arranged that any non-permanent deformation cannot prevent the satisfactory operation of the meter.

The mechanical strength of the meter case shall be tested with a spring hammer. The meter shall be mounted in its normal working position and the spring hammer shall act on the outer surfaces of the meter cover including windows and on the terminal cover with a kinetic energy of  $0.22 \pm 0.05$  Nm.

The result of the test is satisfactory if the meter case and terminal cover do not sustain damage which could affect the function of the meter.

Unless otherwise specified, meters intended to be connected to a supply mains where the voltage under normal conditions exceeds 250V to earth, and whose case is wholly or partially made of metal shall be provided with a protective earth terminal.

**5.2.1.** In case of unsheltered outdoor tropical location exposed to the elements, the meter shall be designed to operate without corrosion or other damage to its parts to adversely affect meter accuracy or reliability.

**5.3. Windows**—The meter cover shall be of molded black phonemic resin or alternatively stamped metal. The meter cover shall be provided with a window of toughened glass through which the movement of the disc (rotor) can be seen and the registers read. The meter may also be equipped with one piece of transparent toughened glass cover.

If the meter cover is not transparent, one or more windows shall be provided for reading the register and observation of the rotor. These windows shall be covered by plates or transparent material which cannot be removed without breaking the seals.



**5.4. Terminals, terminal block(s) and protective earth terminal—**Terminals may be grouped in one or more terminal block(s) having adequate insulating properties and mechanical strength. In order to satisfy such requirements, when choosing insulating materials for the terminal block(s) adequate testing of material should be taken into account.

The holes in the insulating material which form a prolongation of the terminal holes shall be of sufficient size to accommodate the insulation of the conductors.

The material of which the terminal block is made shall be capable of passing the tests for a temperature of 135°C.

Unless otherwise specified by the user, it shall be possible to disconnect easily the relevant voltage terminal(s) from the input current terminals.

**NOTE :** Whether the disconnecting device for the meter voltage circuit will be in the terminal compartment or inside the meter cover, shall be a matter of agreement between the manufacturer and the purchaser.

**5.4.1. Fixing of conductors—**The manner of fixing the conductors to the terminals shall ensure adequate and durable contact such that there is no risk of loosening or undue heating.

Screw connections transmitting contact force and screw fixings which may be loosened and lightened several times during the life of the meter shall screw into a metal nut.

Electrical connections shall be so designed that contact pressure is not transmitted through insulating material.

**5.4.2. Clearances and creepage distances—**The clearances and creepage distances of the terminal block and those between the terminals and the surrounding parts of the metal enclosure shall be not less than the values specified in Table 1 for voltages existing when operating under reference conditions.

**TABLE 1. CLEARANCES AND CREEPAGE DISTANCES**

VOLTAGE (v)	CLEARANCE (mm)	CREEPAGE DISTANCE (mm)
Up to 25	1	1
From 26 to 60	2	2
From 61 to 250	3	3

**5.4.2.1.** For current circuits, the voltage shall be considered to be the same as for the related voltage circuit.



**5.4.2.2.** Terminals with different potentials which are grouped close together shall be protected against accidental short-circuiting. Protection may be obtained by insulating barriers. Terminals of one current circuit are considered to be at the same potential.

**5.4.2.3.** The terminals, the conductor fixing screws or the external or internal conductors shall not be able to come into contact with metal terminal covers.

**5.4.2.4.** The clearance between the terminal cover, if made of metal and the upper surface of the screws when screwed down to the maximum applicable conductor fitted shall be not less than the relevant values specified in Table 1 if the terminal cover is made of insulating material, the clearance shall be not less than 1 mm.

**5.4.3. Protective earth terminal**—The protective earth terminal if any shall—

- (a) be electrically bonded to the accessible metal parts;
- (b) form part of the meter base if possible;
- (c) preferably be located adjacent to its terminal block;
- (d) accommodate a conductor having a cross-section at least equivalent to the main current conductors but with a lower limit of  $6\text{mm}^2$  and upper limit of  $16\text{mm}^2$  (these dimensions apply only when copper conductors are used); and
- (e) be clearly indicated by the earthing symbol.

All parts of every terminal shall be designed such that the risk of corrosion from contact with any other metal part is minimized.

After installation it shall not be possible to remove the protective earth terminal without the use of a tool, coin or any similar device.

**5.5. Terminal cover(s)**—The face cover and terminal cover shall be provided with a security sealing provision to prevent unauthorized access to the internal meter works and connection terminals. Terminal cover sealing provisions shall be designed to accommodate a padlock type meter seal or ferule seal and retaining screw of meter body terminal cover and terminal cover security holes and meter body security holes should be from 3mm to 6mm diameter.

The front cover shall be secured to the base by sellable temper proof screws. Suitable gasket to be attached to the cover to ensure dust mixture and rain-tight joint.

The terminal cover and face cover shall be secured to the base by screws having sealing facility.

The meter shall have a long terminal cover with side hole. Current and voltage coils link shall be provided inside the meter case.



The meter shall be effectively sealed to prevent entrance moisture rain and dust into its internal moving parts.

The terminals of a meter, if grouped in a terminal block, shall have a separate cover which can be sealed independently of the meter cover. The terminal cover shall enclose the actual terminals, the conductor fixing screws and unless otherwise specified a suitable length of the external conductors and their insulation's.

When the meter is panel-mounted, no access to the terminals shall be possible without breaking the seal(s) of the terminal cover(s).

**5.6. Insulating encased meter of protective Class II**—A meter having durable and substantially continuous enclosure made wholly of insulating material, including the terminal cover, which envelopes all metal parts, with the exception of small parts, for example, nameplate, screws, suspensions and rivets. If such small parts are accessible by the standard test finger from outside the case, then they shall be additionally isolated from live parts by supplementary insulation against failure of basic insulation or loosening of live parts. The insulating properties of laquer, enamel, ordinary paper cotton, oxide film on metal parts, adhesive film and sealing compound, or similar unsure materials, shall not be regarded as sufficient for supplementary insulation.

**5.7. Non-flammability**—The terminal block, the terminal cover and the case shall reasonable safety against spread of fire. They shall not be ignited by thermic overload of live parts in contact with them. To comply therewith these parts shall fulfill the conditions of the glow-wire test at the following temperatures :

- |                                   |                                 |
|-----------------------------------|---------------------------------|
| (a) Terminal block                | : $960 \pm 15^{\circ}\text{C}$  |
| (b) Terminal cover and meter case | : $6.50 \pm 10^{\circ}\text{C}$ |

The contact with the glow-wire may occur at any random location. If the terminal block is integral with the meter base it is sufficient to carry out the test only on the terminal block.

**5.8. Register (Counting mechanism)**—The register will be the cyclometer type (drum type). There shall be five integral digit and one decimal digit.

The principal unit in which the register records shall be the kilowatt hour (kWh).

In this type of registers, the principal unit in which the register records shall be marked adjacent to the set of drums. The last drum i.e the drum on the extreme right may be movable continuously.

Drums, when continuously rotating, indicating the lowest values shall be graduated and numbered in ten divisions, each division being subdivided into ten parts or any other arrangement ensuring the same reading accuracy.



Drums of drum-type registers which indicate a decimal fraction of the unit shall when they are visible, be encircled in colour or be coloured (i.e. the digits are indicated by white on black background and decimal black or red on white).

The register shall be able to record, starting from zero for a minimum of 1500 h. the energy corresponding to the rated maximum current at reference voltage and unity power-factor. Any higher values can be agreed upon between the parties concerned.

Register markings shall be indelible and easily readable.

Register will be the "forward counting" mechanism irrespective of the direction of the rotation of the disc (i.e. unidirectional counting register).

**5.9 Direction of rotation and marking of the rotor**— The edge of the rotor nearest an observer viewing a meter from the front shall be move from left to right for positive registration. The direction of rotation shall be marked by a clearly visible arrow. The edge and/or upper surface of the disc shall carry an easily visible mark to facilitate revolution counting. Other marks may be added for stroboscopic or other tests, such marks shall be so placed as not to interfere with the use of the main visible mark for photoelectric revolution counting.

## 6. ELECTRICAL REQUIREMENTS

**6.1 Standard currents**—The standard currents are as given in Table 2.

TABLE 2	STANDARD BASIC CURRENTS
METRES FOR	STANDARD BASIC CURRENTS
Direct connection	5-10-15-20-30-40-50

**6.2 Standard reference voltage**— The standard reference voltage are given in Table 3.

TABLE 3 STANDARD REFERENCE VOLTAGES		
METERS FOR	STANDARD REFERENCE VOLTAGE	EXCEPTIONAL VALUES
	V	V
Direct Connection	127-220-230-240-250	300



### 6.3 Power Losses

(a) **Voltage circuits**—The active and apparent power loss in each voltage circuit of a meter at reference voltage, reference temperature and reference frequency shall not exceed the values shown in Table 4.

TABLE 4 POWER LOSS	
METERS	CLASS OF METER-2
Single-phase	2 W and 8 V A

(b) **Current circuits**—The apparent power taken by each current circuit of a directly connected meter at basis current, reference frequency and reference temperature shall not exceed the values shown in Table 5 for meters with basic current less than 30 A.

TABLE 5 APPARENT POWER LOSS	
METERS	CLASS OF METER-2
Single-phase	2.5 V A

**6.4 Heating**—Under normal conditions of use, windings and insulation shall not reach a temperature which might adversely affect the operation of the meter.

With each current circuit of the meter carrying rated maximum current and with each voltage rarebit (and with those auxiliary voltage circuits which are energized for periods of longer duration than their thermal time constants) carrying 1.2 times the reference voltage. The temperature rise of the respective parts shall not exceed the values given in Table 6 with an ambient temperature not exceeding 40°C.

During the test, the duration of which shall be 2 h. the meter shall not be exposed to draught or direct solar radiation.

TABLE 6 HEATING	
PART OF METER	TEMPERATURE RISE
	°C
Windings	60
External surfaces of the case	25

After the test the meter shall show no damage and shall comply with the voltage tests of 6.5.2. and 6.5.3.



The temperature rise of the windings shall be by the variation of resistance method (see **BDS 414: 1990** Standard of resistance for copper). The measurement shall be carried out at the point of connection between the current winding and the respective terminal.

For the measurement of circuit resistance the cable to be used for energizing the meter shall have a length of about 1 m and a cross section such that the current density is less than  $4 \text{ A/mm}^2$ .

**6.5 Dielectric properties**—The meter and its incorporated auxiliary devices, if any, shall be such that they retain adequate dielectric qualities under normal conditions of use. Taking account of the atmospheric influences and different voltages to which they are subjected under normal condition of use.

Consequently, the meter shall withstand the dielectric voltage tests detailed in 6.5.2. and 6.5.3.

The tests shall be carried out only on a complete meter, with its cover (except when indicated hereinafter) and terminal cover, the screws being screwed down to the maximum applicable conductor fitted in the terminals.

These tests shall be carried out only on a meter, given in **BDS 1389: 1993**. During type tests the dielectric property tests are considered to be valid only for the terminal arrangement of the meter which has undergone the test. When the terminal arrangements differ, all the dielectric property tests shall be carried out again.

For the purpose of these tests, the term earthy has the following meaning:

- (a) When the meter case is made of metal, the earth is the case itself placed on a flat conducting surface.
- (b) When the meter case or only a part of it is made of insulating material, the earth is a conductive foil wrapped around the meter and connected to the flat conducting surface on which the meter base is placed. Where the terminal cover makes it possible, the conductive foil shall approach the terminals and the holes for the conductors within a distance of not more than 2 cm.

During the impulse ac voltage tests, circuits which are not under test are connected either to the frame or to the earth as indicated hereinafter.

The inputs voltage test are carried out first and the ac voltage tests afterwards.

During these tests, no flashover, disruptive discharge or puncture occur.



After these tests, there shall be change in the percentage error of the meter greater than the uncertainty of the measurement.

In this clause, the expression all the terminals means the whole set of the terminals of the current circuits, voltage circuits and, if any, auxiliary circuits having a reference voltage over 40V.

**6.5.1 General conditions for dielectric qualities tests**—These tests shall be made in normal conditions of use. During the test the quality of the insulation shall not be impaired by dust or abnormal humidity.

Unless otherwise specified, the normal conditions for insulation tests are:

Ambient admperture	5 °C to 45 °C
Relative humidity	max 95%
Atmsphere pressure	86 kpa to 106 kpa (860 mbar to 1060 mbar)

**6.5.2 Impulse voltage test**—The impulse voltage tests are intended to determine the capability of the meter to withstand, without damage, shcrt time over voltage of high values.

**NOTE**—The aim of the test is sub clause 6.5.1. is essentially to ensure, on the one hand, the quality of the insulation of the voltage windings between turns or between layers and, on the other hand, the insulation between different circuits of the meter which in ncrmal service are connected to conductors of different phases of the network and between which over voltage may occur.

The test in 6.5.2.2. is intended to provide overall verification of the behavior of the insulation of all the electrical circuits in the meter relative to earth. This insulation represents an essential safety factor for personnel in the event of over voltage on the network.

The energy of generator used for the test shall be in accordance with the relevant requirements of **BDS 1389:1993\*** The waveform of the impulse is the standardized 1.2/50 and its peak value is 6KV for each test the impulse voltage is applied ten times with the same polarity.

**6.5.2.1 Tests of insulation for circuits and of insulation between the circuits**—The test shall be made independently on each circuit (or assembly of circuits) which are insulated from the other circuits of the meter in normal use. The terminals of the circuits which are not subjected to impulse voltage shall be connected to earth.



Thus when in normal use the voltage and the current circuits of a driving element are connected together, the test shall be made on the whole. The other end of the voltage circuit shall be connected to earth and the impulse voltage shall be applied between the terminal of the current circuit and earth. When several voltage circuits of a meter have a common point this point shall be connected to earth and the impulse voltage successively applied between each of the free ends of the connections (of the current circuit connected to it) and earth.

When, in normal use, the voltage and the current circuits of the same driving element are separated and appropriately insulated (e.g. each circuit connected to measuring transformer), the test shall be made separately on each circuit.

During the test of current circuit, the terminals of the circuits shall be connected to earth and the impulse voltage shall be applied between one of the terminals of the current circuit and earth. During the test of a voltage circuit, the terminals of the other circuits and one of the terminals of the voltage circuit under test shall be connected to earth and the impulse voltage shall be applied between the other terminals of the voltage circuit and earth.

The auxiliary circuits intended to be connected either directly to the same voltage transformers as the meter circuits and with a reference voltage over 40V shall be subjected to the impulse voltage test in the conditions as those already given for voltage circuits. The other auxiliary circuits shall not be tested.

**6.5.2.2. Test of insulation of electric circuits relative to earth**—All the terminals of the electric circuits of the meter, including those of the auxiliary circuits with a reference voltage over 40V shall be connected together.

The auxiliary circuits with a reference voltage below or equal to 40V shall be connected to earth. The impulse voltage shall be applied between all the electric circuits and earth.

**6.5.3.A.C Voltage test**—The ac voltage tests shall be accordance with Table 7.

The test voltage shall be substantially sinusoidal, having a frequency between 45 Hz and 65 Hz, and applied for one minute. The power source shall be capable of supplying at least 500 VA.

During the tests relative to the frame (A in Table 7), the circuits which are not under test shall be connected to the frame.

During the test relative to earth (C in Table 7), the auxiliary circuits with reference voltage equal to or below 40 V shall be connected to earth.



TABLE 7 AC VOLTAGE TESTS

TEST VOLTAGE r.m.s	POINTS OF APPLICATION OF THE TEST VOLTAGE
2KV (For tests in Items (a), (b), (c), (d).  and 500 V (for test in Item e)	A. Tests which may be carried out with the cover and terminal cover removed. —between, on the one and the frame and —on the other hand: (a) Each current circuit which, in normal service, separated and suitably insulated from the other circuits. (b) Each voltage circuit, or set of voltage circuits having a common point which in normal service, is separated and suitably insulated from the other circuits.* (c) Each auxiliary circuit or set of auxiliary circuits having a common point, and whose reference voltage is over 40V. (d) Each assembly of current voltage windings of one and the same driving element which, in normal service, are connected together but separated and suitable insulated from the other circuits.** (e) Each auxiliary circuit whose reference voltage is equal to or below 40V.
600 V or twice the voltage applied to the voltage windings under reference conditions. When this voltage is greater than 500V (the higher value).	B. Test which may be carried out with the terminal cover removed but with the cover in place when it is made of metal between the current circuit and the voltage circuit of each driving element, normally connected together, this connection being temporarily broken for the purpose of the test.+
2KV 4KV (for test in Item a)	C. Test to be carried out with the case closed, cover and terminal cover in place between, on the one hand all the current and voltage circuits as well as the auxiliary circuits whose reference voltage is over 40V, connected together and on the other hand earth.
2KV (for test in Item b)	D. Additional tests for insulation encased meters of protective class II
40V (for test in Item d)	a. Between on the one hand, all the current and voltage circuits as well as the auxiliary whose reference voltage is over 40V, connected together and on the other hand earth: b. between the frame and earth: c. a visual inspection for compliance with the conditions of 5.6. d. between on the one hand, all conductive parts inside the meter case connected together and, on the other hand all conductive parts outside the meter case that are accessible with the test finger connected together.+



\* The simple breaking of the connection which is normally included between current and voltage windings is not generally sufficient to ensure suitable insulation which can withstand a test voltage of 2KV.

Test in Items (a) and (b) generally apply to meters operated from instrument transformers and also to certain special meters having separate current and voltage windings.

\*\* Circuits which have been subjected to tests in items (a) and (b) are not subjected to the test in item (d) when the voltage circuits of a polybase meter have a common point in normal service, this common point shall be maintained for the test and, in this case all the circuits of the driving elements are subjected to a single test.

+ It is not strictly speaking dielectric length test but a means of verifying that the insulation distances are sufficient when the connecting device is open.

++ The test in item (d) of part D is not necessary if the test item (c) leaves no doubt.

**6.5.4. Weather meter test of meters for outdoor use only—** The sample meter shall be mounted in the normal operating position in the weather meter. Bottom connected meters shall be treated without housing accessories. Detachable meters shall be tested with a standard socket and sealing ring and with the conduit sealed against moistures. The meters shall then be exposed for 14 days to the following weather meter condition:

1. Direct ultraviolet radiation throughout approximately 93% of the weather meter cycle.
2. Fresh water spray applied to the front and top of the meter through out approximately 7% of the weather meter cycle, the time for the complete cycle being 18 minutes.

After this test, covers, terminal covers, etc. shall be readily removable, and there shall be no progressive corrosion or electrolytic action that will adversely affect the functioning of any part of the apparatus. Also there shall be no evidence of deleterious discoloration or fading of finishes on materials.

**6.5.5. Salt spray test—**The sample meter shall be mounted in its normal operating position in a salt spray chamber and subjected to a 500 hours salt spray test. Bottom connected meters shall be tested without housing accessories. Detachable meters shall be tested with a standard socked and sealing ring and with the conduit holes sealed against moisture.

After this test covers, terminal covers, etc. shall be readily removable, and there shall be no progressive corrosion or electrolytic action that will adversely affect the functioning of any part of the apparatus.



## 7. MARKING

**7.1 Nameplate**—Every meter shall be marked with the following information. The marking shall be indelible, distinct and readable from outside the meter:

- (a) Manufacturer's or trade mark and country's name.
- (b) Designation of type.
- (c) The nature of current (for example a c) and the number of phases and number of wires for which the meter is suitable (for example single phase 2 wire).
- (d) The serial number and year of manufacture.
- (e) Principle unit in which the meter records (for example KWh).
- (f) The reference voltage in one of the forms given in Table 3.
- (g) The reference frequency in Hz.
- (h) The meter constant, for example in the form: X rev/K Wh.
- (i) The class index for example, call 2.
- (j) The reference temperature, if different from 27°C
- (k) Current rating (basic and maximum)

**NOTE**—By agreement between manufacturers and the purchasers, the additional markings shall be given by the manufacturers.

All meter shall be supplied in factory calibrated and sealed condition along with copy of routine test certificates.

**NOTE**—1. The information under (a), (b) and (c) may be marked on an external plate permanently attached to the meter cover.

The information under (d) to (k) shall be marked on a nameplate preferably placed within the meter, and which may, for example, be attached to the meter register. The information may marked on the meter dial.

2. If the meter is of a special type (for example, provided with a reversal preventing device or, intended for a capacitive load) this shall be indicted on the nameplate or on a separate plate.

3. Standard symbols may also be used.

**TABLE 8 VOLTAGE MARKINGS**

TYPE OF METER (1)	METHOD OF MARKING (2)	EXAMPLE (3)
Single-phase, 2 wire, Direct Connected	voltage between line and neutral	2.30

TABLE 9 CURRENT MARKINGS

(1)	(2)	(3)
Single phase, whole current		
1 <sub>b</sub> 10A, I <sub>max</sub> 40A	Basic current and rated	10-40A
1 <sub>b</sub> 10 A. I <sub>max</sub> 60-A	Maximum current	10-60A

7.2 The meter may also be marked with the BSTI Certification Mark.

**NOTE :** The use of the BSTI Certification Mark is governed by the provisions of the Bangladesh Standards and Testing Institution Ordinance, 1985 and the Rules and Regulations made thereunder. Details of conditions under which a licence for the use of the BSTI Certification Mark may be granted to manufacturers or processors, may be obtained from the Bangladesh Standards and Testing Institution.

7.3 Connection diagrams and terminal margins (See Figure 1)

7.3.1 Every meter shall be indelibly marked with a diagram of connection including the meter terminals.

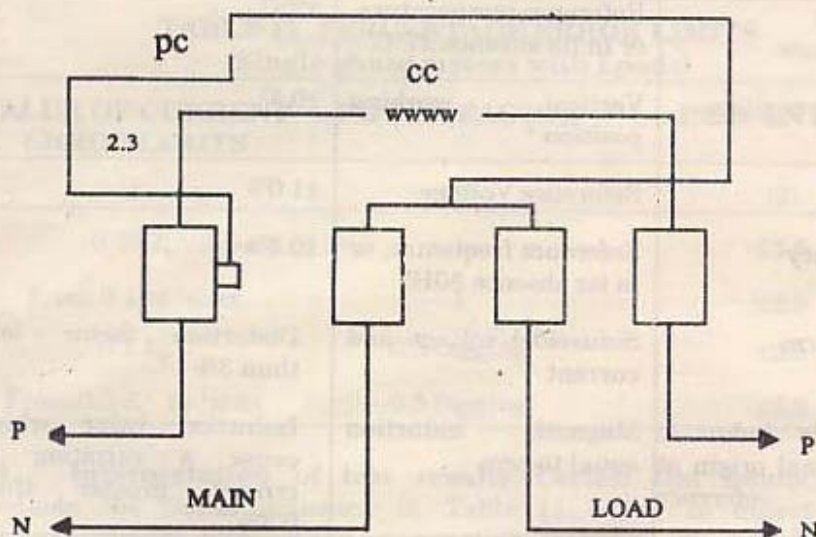

Fig.1 Circuit diagram of connections for a single phase two-wire meter



8. ACCURACY

8.1 Conditions under Which the tests shall be carried out

- (a) The meter cover shall be in position.
- (b) For drum type (cyclometer type) registers, only the most rapidly moving drum shall be turning.
- (c) Before any tests are made, the voltage circuits shall have been energized for at least 1 h for class 2 meters.

and the measuring currents shall be set progressively to increasing or decreasing values and the current circuits shall be energized at each value for a sufficient time to obtain thermal stability with corresponding constant speed of rotation.

TABLE 10. REFERENCE CONDITIONS OF INFLUENCE QUANTITIES

INFLUENCE QUANTITY	REFERENCE VALUE	PERMISSIBLE TOLERANCES
(1)	(2)	(3)
Ambient temperature	Reference temperature, or in its absence 27°C*	±2°C
Working position	Vertical working position +	±0.5°
Voltage	Reference Voltage	±1.0%
Frequency	Reference frequency, or in its absence 50Hz	±0.5%
Wave form	Sinusoidal voltage and current	Distortion factor less than 3%
Magnetic induction of external origin at the reference frequency	Magnetic induction equal to zero	Induction value which cause a variation of error greater than 0.3%**

\* If the tests are made at a temperature other than the reference temperature, including permissible tolerances, the results shall be corrected by applying the appropriate temperature coefficient of the meter.

+ **Determination of the vertical working position**— The construction and assembly of the meter should be such that the corrected vertical position is ensured (in both the front to back and left to right vertical plans) when:

- (a) the base of the meter is supported against a vertical wall and
- (b) a reference edge (such as the lower edges of the terminal block) or a reference line marked on the meter case is horizontal.

\*\* **The test consists of—**

For a single phase meter, determining the errors at first with the meter normally connected to the mains and then after inverting the connections to the current circuits as well as to the voltage circuits. Half of the difference between the two errors is the value of the variation of error. Because of the unknown phase of the external field, the test has to be made at 0.1 lb at unity power factor and 0.2 lb at 0.5 power factor.

8.2 **Limits of errors**— When the meter is under the reference conditions given in 8.1 the percentage errors shall not exceed the limits for accuracy as given in Table 11.

8.3 **Test of meter constant**—It shall verified that the ratio between the number revolutions of the meter rotor and the indication of the register is correct.

**TABLE 11 PERCENTAGE ERROR LIMITS**  
(Single phase meters with Loads)

VALUE OF CURRENT ERROR LIMITS	POWER FACTOR	PERCENTAGE
(1)	(2)	(3)
0.05 $I_b$	1	±2.5
From 0.1 to $I_{max}$	1	±2.0
0.1 $I_b$	0.5 lagging	±2.5
From 0.2 $I_b$ to $I_{max}$	0.5 lagging	±2.0

8.4 **Interpretation of test results**—Certain test results may fall outside the limits indicated in Table 11 owing to uncertainties of measurements and other parameters capable of influencing the measurements. However, if by one displacement of the zero line parallel to itself by no more than the limits indicated in Table 12 all the test results are brought within the limits indicated in Table 11. The meter type shall be considered acceptable.



TABLE 12 INTERPRETATION OF TEST RESULTS

PREMISSABLE DISPLACEMENT OF THE ZERO LINE (%)	1.0 FOR CLASS 2 METER
-----------------------------------------------	-----------------------

8.5 **Effect of influence quantities**—When determining the effect of an individual influence quantity, the conditions and the values of all other influence quantities shall be stand 8.1.

The influence quantities taken into consideration for fixing the above reference conditions and evaluating their effects on the results of various tests are as follows:

- ambient temperature
- working position
- voltage
- frequency
- waveform
- magnetic induction of external origin.

8.5.1. **Influence of ambient temperature**—The determination of the mean temperature coefficient for given temperature shall be made over a temperature range of 20°C, 10°C below that temperature, but in no case shall the temperature be lower than 0°C.

The mean temperature coefficient shall in all cases be determined at least for the reference temperature and shall not exceed the limits given in Table 13.

TABLE 13 TEMPERATURE COEFFICIENT

VALUE OF CURRENT	POWER FACTOR	MEAN TEMPERATURE COEFFICIENT, %°C
From 0.1 $I_b$ to $I_{max}$	1	0.10
From 0.2 $I_b$ to $I_{max}$	0.5 lagging	0.15

8.5.2. **Other influence quantities**—Other influence quantities are as given in Table 14.

TABLE 14 INFLUENCE QUANTITIES

CHANGE IN THE VALUE OF THE INFLUENCE EQUANTITIES WITH RESPECT TO REFERENCE CONDITIONS	VALUE OF CURRENT BALANCED LOAD UNLESS OTHERWISE STATED	POWER-FACTOR	LIMITS OF VARIATION IN PERCENTAGE ERROR FOR METERS OF CLASS 2
Oblique suspension 3 <sup>c</sup>	0.05 $I_b$	1	3.0
	$I_b$ and 1 max	1	0.5
Voltage $\pm 10\%$	0.1 $I_b$	1	1.5
	0.5 1max	1	1.0
	0.5 1max	0.5 lagging	1.5
Frequency $\pm 5\%$	0.1 $I_b$	1	1.5
	0.5 1 max	1	
	0.5 1 max	0.5 lagging	
Magnetic induction of external origin 0.5 mT <sup>†</sup>	$I_b$	1	3.0
Waveform : 10% of third harmonic in the current <sup>**</sup>	$I_b$	1	0.8
Reversed phase sequence	From 0.5 $I_b$ to 1 max	1	1.5
	0.5 $I_b$	1	2.0
Magnetic field of an accessory <sup>†</sup>	0.05 $I_b$	1	1.0
Mechanical load of either single or multi rate register <sup>††</sup>	0.05 $I_b$	1	2.0

<sup>†</sup>A magnetic induction of external origin of 0.5 mT produced by a current of the frequency as that of the voltage applied to the meter and under the unfavorable conditions of phase and direction shall not cause a variation in the percentage error of the meter exceeding the values shown in Table 14.

This magnetic induction may be obtained by placing the meter in the centre of a circular coil. I m in mean diameter of square section and of small radial thickness relative to the diameter, and having 400 ampere turns.



\*\* The distortion factor of the voltage shall be less than 1%.

The variation in percentage error shall be measured under the most unfavorable phase displacement of the third harmonics in the current compared with the fundamental current.

+ Such an accessory, enclosed in the meter case is energized intermittently for example the electromagnet of a multi-rate register.

It is preferable that the connection to the auxiliary devices be marked to indicate the correct method of connection. When these connections are made by means of plugs and sockets, these connections should be irreversible. However, the variations of errors shall not exceed those indicated in Table 14 when the meter is tested with the connections giving the most unfavorable condition.

++ The effect is compensated when calibrating the meter.

8.6 **Short-time over currents**—The test circuit shall be practically non-inductive.

After test application of the short time over current with the voltage maintained at the terminals, the meter shall be allowed to return to the initial temperature with the voltage circuit energized (about one hour).

8.6.1 **Meter for direct connection**—The meter shall be able to carry an impulse current\* whose peak value equals 50 times rated maximum current (or 3500 A, whichever is less) during 1 ms.

After this test, the variation of the error shall not exceed the value shown in Table 15.

\* This impulse current can be obtained, for example, by a capacitor discharge or thyristor control of the mains supply.

TABLE 15 VARIATIONS DUE TO SHORT-TIME OVERCURRENT'S			
METERS FOR	VALUE OF CURRENT	POWER FACTOR	LIMITS OF VARIATION IN PERCENTAGE ERROR
Direct connection	1b	1	1.5

8.7 **Influence of self-heating**—After the voltage circuits have been energized at reference voltage for at least 1b, without any current in the current circuit, the rated maximum current shall be applied to the current circuits. The meter error shall be measured at unity power-factor immediately after the current is applied and then at intervals short enough to allow a correct drawing to be made of the curve of error variation as a function of time. The test shall be carried out for at least 1 h, and in any event until the variation of error during 20 min does not exceed 0.2%.

The same test shall then be carried out at 0.5 (lagging) power-factor.

The variation of error, measured as specified, shall not exceed the values given in Table 16.



**TABLE 16 VARIATIONS DUE TO SELF-HEATING**

VALUE OF CURRENT	POWER FACTOR	LIMITS OF VARIATION IN PERCENTAGE ERROR
$I_{max}$	1	1.0
$I_{max}$	0.5 lagging	1.5

## 9. STARTING AND RUNNING WITH NO-LOAD

For these tests, the conditions and the values of the influence quantities shall be as stated in 8.1 except for any changes specified below.

**9.1 Starting**—The rotor of the meter shall start and continue to run at the current shown in Table 17.

**TABLE 17 STARTING CURRENTS**

	PERCENTAGE OF BASIC CURRENT	POWER-FACTOR
Single-rate meter	0.5	1

It shall be verified that the rotor complete at least one revolution for meters with drum-type (cyclometer) registers the tests shall be made with not more than two drums moving.

**9.2 Running with no-load**—With no current in the circuits the rotor of the meter shall not make a complete revolution at any voltage between 80% and 110% of the reference voltage.

For drum-type (cyclometer) registers these conditions shall apply with only one drum moving.

## 10. ADJUSTMENT

**10.1** Generally suitable means of adjustment are provided. It shall be provided with means for (a) low load, (b) full load and (c) inductive load adjustment, preferably by use of a simple tool, with means of locking in the set position, meter adjustment provisions shall be readily visible and accessible and adjustments made without requiring the use of specially designed tools.



A meter provided with means of adjustment and which has been adjusted satisfactorily according to this standard shall be capable of being further adjusted at least to the extent shown Table 18.

Tests shall be made under the conditions stated in 8.1.

**TABLE 18 MINIMUM RANGE OF ADJUSTMENT**

ADJUSTMENT	VALUE OF CURRENT	POWER FACTOR	MINIMUM RANGE OF ADJUSTMENT OF ROTATION SPEED OF THE ROTOR IN PERCENTAGE
Braking element	0.5 <sup>1</sup> max	1	±4
Low load	0.05 <sup>1b</sup>	1	±4
Inductive load	0.5 <sup>1</sup> max	0.5 lagging	±1

## 11. CLASSIFICATION OF TESTS

11.1. **Type Tests**— Tests schedule and sequence shall be as given in Table 19.

**TABLE 19 SCHEDULE OF TYPE TESTS**

1.	Insulation resistance	11.4
2.	Running with load	9.2
3.	Starting	9.1
4.	Limits of errors	8.2
5.	Interpretation of test results and adjustment (if required)	8.4
6.	Test of meter constant	8.3
7.	Power loss	6.3
8.	Heating	6.4
9.	Dielectric strength	6.5
10.	Effect of influence quantities	8.5
11.	Effect of self-heating	8.7
12.	Range of adjustment	10

**11.1.1 Number of samples and criteria for conformity**—Type tests shall be applied to three test specimens in the event of one specimen failing to comply in any respect, a further three specimens shall be taken all of which shall comply with the requirements of this standard.

**11.2 Acceptance test**—Test schedule and sequence shall be as given in table 20.

**11.2.1 Recommended sampling plan and criteria for acceptance**—A recommended sampling plan and the criteria for acceptance of the lot are given in Appendix A.

**11.3 Routine test**—Test schedule and sequence shall be as given in Table 21.

**11.4 Insulation resistance**—The Insulation resistance test shall be carried out in accordance with Table 22. the voltage shall be applied for minimum of one minute or a sufficient time for a the pointer of the insulation tester to have come practically rest.

**TABLE 20. SCHEDULE OF ACCEPTANCE TESTS**

SL.NO	TESTS	CLASS REF.
(1)	(2)	(3)
1.	Insulation resistance	11.4
2.	Running with no load properties	9.2
3.	Starting	9.1
4.	Limits of errors	8.2
5.	Interpretation of test results and adjustment (if required)	8.4
6.	Range of adjustment	10



TABLE 21 SCHEDULE OF ROUTINE TESTS

SL.NO	TESTS	CLASS REF
(1)	(2)	(3)
1.	Insulation resistance	11.4
2.	Dielectric strength	6.5
3.	Running with no load	9.2
4.	Starting	9.1
5.	Limits of errors	8.2
6.	Interpretation of test results and adjustment (if required)	8.4

TABLE 22 INSULATION RESISTANCE TESTS

TEST VOLTAGE	POINTS OF APPLICATION OF THE TEST VOLTAGE	INSULATION RESISTANCE MIN
(1)	(2)	(3)
		M Ω
500±50 V dc	(a) Between the frame and, current circuits, voltage circuits, and, auxiliary voltage circuits, if any, all connected together .	500
	(b) Between each current circuit (or voltage circuit) and each and every other circuit.	5

\* Where two more voltage circuits are permanently joined together, the combination may be treated as one circuit for this test.

## APPENDIX-A

(Sub-Clause 11.2.1)

## RECOMMENDED SAMPLING PLAN

## A-1. LOT

A-1.1 In any consignment, all meters of same capacity and dimensions from the same batch manufactured by the same factory shall be grouped together to constitute a lot.

## A-2 DEFECTIVE METER

A-2.1 Any meter which does not satisfy the requirements of one more respective acceptance tests shall be considered as defective meter.

A-3 In Table 23  $N_1$  is the size of first sample (random). If the number of defective meter is equal to  $C_1$  the lot shall be accepted. If the number of defective meter is equal to or greater than  $C_2$ , the lot shall be rejected. If the number of defective meter is in between  $C_1$  and  $C_2$ , a further sample of  $N_2$  meter shall be selected and subjected to all tests. If the number of defective meter in the two samples combined is less than  $C_2$ , the lot shall be accepted. If the number of defective meters in the two samples combined is equal to or greater than  $C_2$ , the lot shall be rejected.

TABLE 23 SAMPLING PLAN

LOT SIZE	$N_1$	$N_2$	$N_1 + N_2$	$C_1$	$C_2$
up to 500	10	15	25	0	2
501-1000	15	20	35	0	3
1001-2000	20	30	50	1	4
2001-3000	30	40	70	2	4

**NOTE:** The sampling procedure shall be subjected to agreement between the supplier and the user, in the absence of such an agreement, the procedure mentioned above shall be adopted.



## APPENDIX-B

## GRAPHICAL SYMBOLS FOR WATT-HOUR METERS

**B-1** The symbols shown below by way of examples are derived by representing each voltage winding by a line, and each current winding by a black or white dot (small circle).

The dot representing the current winding of meter elements is placed at one or other end of the line representing the voltage winding of the same meter element when the two windings have a common point. If two or three voltage windings have a common end this is represented by lines meeting at point the angles between two of the lines indicate (with the appropriate sign convention) the phase difference between the voltages. If this angle is  $180^\circ$  the common point is marked by a small line (see symbol c). The number of lines also indicate the number of meter elements.

**B-2 EXAMPLE**

(a)



Symbol (a) indicates a meter with one element having one current winding and one voltage winding (for one-phase 2-wire circuits).

(b)

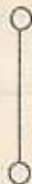

Symbol (b) indicates a meter with one element, having one voltage winding and two current windings (for one-phase 2 or 3-wire circuits when the voltage winding is connected across the outer conductors).

(c)



Symbol (c) indicates a meter having two elements each having a voltage winding and current winding which later are connected in the outers of a one-phase 3-wire circuit, the corresponding voltage windings being connected between outers and the mid-wire.

(d)

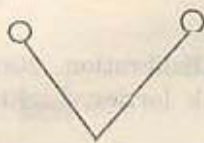

Symbol (d) indicates a meter having two elements, each having a voltage winding and a current winding, each of which later is inserted in a phase conductor of a three-phase circuit. The voltage winding of each element being connected between the neutral and the phase conductor in which its current winding is inserted.

(e)

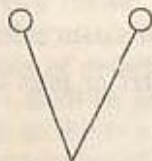

Symbol (e) indicates a meter having two elements, each having a voltage winding and a current winding, and connected for the 2-wattmeter method (for three-phase 3-wire circuits).

(f)

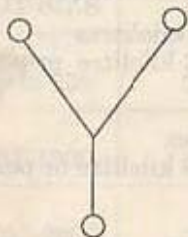

Symbol (f) indicates a meter having three elements, each having a voltage winding and a current winding, and connected for the 3-wattmeter method (for three-phase 4-wire circuits).

(g)



Symbol (g) indicates a meter having two elements, each having a voltage winding and a current winding, which later are connected in the two-phase conductors of a two-phase 3-wire circuits.



**Schedule XXIV**  
**(See Rule 18)**  
**Schedule XI (A)**

Fees for verification, re-verification, calibration, re-calibration, stamping and for certificate of all kinds of storage tanks, tank lorries, Lighterage, Burge.

1. All kind of Storage Tank, Burge, Lighterage etc.

Services charges	Verification & stamping fees
For first 50 kilolitre or part thereof @ Tk. 3000 (Minimum)  Next 100 kilolitre @ Tk. 20 per kilolitre  Next 200 kilolitre @ Tk. 15 per kilolitre  Next 300 kilolitre @ Tk. 10 per kilolitre  For rest of the litres @ Tk. 5 per kilolitre	(a) Verification and certification charges for physical calibration.  For first 10 kilolitres  <div style="text-align: center;">and</div>  @ Tk. 30 per kilolitre or part thereof. plus  Next 20 kilolitres @ Tk. 25 per kilolitre or part thereof. plus  Next 30 kilolitres @ Tk. 15 per kilolitre or part thereof. plus  For the rest of the litres @ Tk. 10 per kilolitre or part thereof.
	(b) Strapping and measurement  For the first 1000 kilolitres @ Tk. 200 per 100 kilolitre or part thereof.  Next 1000 kilolitres @ Tk. 150 per 100 kilolitre or part thereof.  Next 3000 kilolitres @ Tk. 100 per 100 kilolitre or part thereof.  Next 5000 kilolitres @ Tk. 50 per kilolitre or part thereof.  For the rest of the litres @ Tk. 10 per 100 kilolitre or part thereof.

## 2. Tank Lorry

Service charges	Verification & stamping fees
Tk. = 1000 for each Tank lorry (Fixed)	@ Tk. = 300 for each Tank lorry (for two chamber) and Tk. 450 for three chambers. (Maximum capacity 4500 liter of each chamber).

## 3. Metre

Instrument	Verification & Stamping fees
(a) Taxi meter	Tk. = 150.00 for each meter
(b) Water meter	Tk. = 100.00 for each meter
(c) Volumetric gas meter	Tk. = 100.00 for each meter
(d) Meters for liquids (other than water)	Tk. = 100.00 for each meter
(e) Bulk meter/Flow meter	Tk. = 1000.00 for each meter
(f) A.C Energy meter	Tk. = 25.00 for each meter

### Schedule XI (B)

Fees/charges payable for calibration, verification and stamping of weights, measures, weighing instruments and measuring instruments etc. under Industrial, Scientific Metrology (including Working Standards):—

Instrument/Denomination	Fees/charges per piece
<b>1. Metric weights:</b>	
50 kg	100.00
20 kg	50.00
10 kg	25.00
5kg	20.00
From 2 kg to 100 g	10.00
From 50 g to 1 mg	5.00



Instrument/Denomination	Fees/charges per piece
<b>2. Metric weighing instruments:</b>	
Above 50 Tonnes	2,500.00
Above 20 Tonnes but not exceeding 50 Tonnes	2,000.00
Above 5 Tonnes but not exceeding 20 Tonnes	1,500.00
Above 2 Tonnes but not exceeding 5 Tonnes	1,000.00
Above 500 kg but not exceeding 2 Tonnes	500.00
Above 50 kg but not exceeding 500 kg	300.00
Above 5 kg but not exceeding 50 kg	200.00
Up to 5 kg	100.00
<b>3. Litre Measures (Tin/Steel):</b>	
100 litre	500.00
50 litre	400.00
20 litre	300.00
10 litre	200.00
5 litre	100.00
2 litre	50.00
1 litre	40.00
From 500 ml to 100 ml	20.00
From 50 ml to 1 ml	10.00
<b>4. Measuring cylinder, Burette, Pipette, etc. (Glass/Glass fibre):</b>	
Above 1 litre	125.00
Above 200 ml up to 1 litre	60.00
Above 50 ml up to 200 ml	25.00
Up to 50 ml and below	15.00
(b) Glass Syringe up to 20 ml	200.00

Instrument/Denomination	Fees/charges per piece
<b>5. Length Measures:</b>	
(a) Measuring Tape:	
Above 100 metre (Glass/Glass fibre)	1,000.00
Above 50 metre up to 100 metre	700.00
Above 20 metre up to 50 metre	500.00
Above 10 metre up to 20 metre	300.00
Above 1 metre up to 10 metre	150.00
Up to 1 metre	100.00
(b) Slide calliper/Scrow gauge/ micrometer/Gauge block:	
(Any denomination)	300.00
(c) Dip rod:	
Above 2 metre	300.00
Above 1 metre up to 2 metre	200.00
Up to 1 metre	100.00
(d) Length Counter metre:	
Above 10,000 metre	1,000.00
10,000 metre & below	500.00
<b>6. Pressure gauge:</b>	
From 1 Pa to 10 Pa	100.00
Above 10 Pa to 100 Pa	200.00
Above 100 Pa to 1 KPa	300.00
Above 1 KPa to 50 KPa	400.00
Above 50 KPa to 100 KPa	500.00
Above 100 KPa to 500 KPa	750.00
Above 500 KPa to 1 MPa	850.00
Above 1 MPa to 1 GPa	1,000.00



Instrument/Denomination	Fees/charges per piece
<b>7. (a) Volume (physical calibration):</b>	
Up to 1000 litre	500.00
From 1001 litre to 2000 litre	1,000.00
From 2001 litre to 3000 litre	1,500.00
From 3001 litre to 5000 litre	2,000.00
<b>(b) Flow Metre:</b>	
Up to 1000 litre	1,000.00
From 1001 litre to 2000 litre	1,500.00
Above 2000 litre	2,000.00
<b>8. Thermometer:</b>	
(i) Clinical thermometer:	300.00
(ii) General thermometer (other than clinical):	
0-50°C	45.00
0-100°C	60.00
0-200°C	90.00
0-400°C	120.00
Above 400°C	180.00
(iii) Standard thermometer :	
0-100°C	90.00
0-200°C	120.00
0-400°C	180.00
Above 400°C	225.00
(iv) Temperature indicator (any range)	300.00
<b>9. Electric Equipment:</b>	
Ampere meter, Volt meter, Resistance (ohm) metre, Watt meter, etc. (any denomination)	1,000.00

Instrument/Denomination	Fees/charges per piece
<b>10. Other equipment:</b>	
(a) Timer, Pull gauge,	300.00
(b) Anemometer, Manometer, Hygrometer etc. (any denomination)	1,000.00
(c) Compressive Test M/C Up to 50 ton and below Above 50 ton	1,500.00
(d) Tensile Test M/C	1,000.00
(e) Sieve (any denomination)	300.00

**N.B.**—Calibration fees may be determined by the Director General of BSTI for the equipment not mentioned in the schedule of rules.

রাষ্ট্রপতির আদেশক্রমে

ড. মোহাম্মদ আইয়ুব মিয়া  
অতিরিক্ত সচিব।

মোঃ নূর-নবী (উপ-সচিব), উপ-নিয়ন্ত্রক, বাংলাদেশ সরকারী মুদ্রণালয়, ঢাকা কর্তৃক মুদ্রিত।  
মোঃ আমিন জুবেরী আলম, উপ-নিয়ন্ত্রক, বাংলাদেশ ফরম ও প্রকাশনা অফিস,  
তেজগাঁও, ঢাকা কর্তৃক প্রকাশিত।